

[concept·s][®]

□ CAROLINE[®] HOME & LIVING



Modulares Einrichtungs- system für die individuelle Gestaltung Ihrer Wohn- und Lebensräume

modular furnishing system
for designing individual home
and living interiors

Konzeption & Herstellung
concept-s Team
Stand 04/2024

conception & production
concept-s team
as of 04/2024

**Technische und preisliche Änderungen vorbehalten.
Es gelten unsere Allgemeinen Geschäftsbedingungen.
Reproduktion von Kataloginhalten ohne Genehmigung,
auch auszugsweise, ist nicht gestattet.**

Subject to technical modifications and price changes.
Our General Terms and Conditions apply.
Reproduction of catalogue content without permission,
even in extracts, is not permitted.

□ CAROLINE® HOME & LIVING



Photo by Javier Miranda on Unsplash

CAROLINE* ist ein innovatives und patentiertes Einrichtungssystem von [concept-s], das durch filigranes Design aus dünnen Stahlprofilen besteht. Dank der Variabilität in Höhe und Breite eignet sich CAROLINE* perfekt für alle Wohnbereiche und Lebensräume.

CAROLINE* is an innovative and patented furnishing system from [concept-s] that impresses with its filigree design made of thin steel profiles. Thanks to its variability in height and width, CAROLINE* is perfect for all home areas and living spaces.

* eingetragenes Deutsches Gebrauchsmuster Nr. 20 2021 100 626 / Europäisches Patent Nr. EP 4 039 131 B1
* registered German utility model no. 20 2021 100 626 / European patent no. EP 4 039 131 B1



Entwurf & Planung

design & planning

Ihre persönliche Wunschausstattung können Sie mit dem CAROLINE HOME & LIVING Konfigurator selbst zusammenstellen oder Sie erhalten von uns eine persönliche Beratung mit einem maßgeschneiderten Angebot.

You can create your own customised design using the CAROLINE HOME & LIVING configurator - or we will be happy to advise you personally and prepare a made-to-measure offer for you.



flexibel & vielseitig

flexible & versatile

1 System - unzählige Möglichkeiten:
durch das einfache Umbauen von Gitterstruktur und / oder Komponenten entstehen immer wieder neue individuelle Einrichtungselemente

1 system - countless possibilities:
by simply converting the grid structure and / or components, new individual furnishing elements are created continuously



Verpackung & Versand

packaging & shipping

Durch den modularen Aufbau kann CAROLINE in kompakten Verpackungseinheiten versendet werden, das spart Platz, Kosten und schont die Umwelt.

Due to its modular concept, CAROLINE can be shipped in compact packaging units, which saves space, reduces costs, and protects the environment.



hochwertig & nachhaltig

high-quality & sustainable

Die hochwertigen Materialien gewährleisten eine lange Haltbarkeit und durch die verschiedenen Verwendungsmöglichkeiten ist CAROLINE besonders nachhaltig.

The high-quality materials ensure long durability and the various possibilities of application make CAROLINE particularly sustainable.

Gitterstruktur

grid structure

Unser innovatives Einrichtungssystem ist in verschiedenen Höhen und Breiten erhältlich. Entscheiden Sie sich für Ihre passende Größe in hoch- oder querformatiger Ausrichtung und wählen Sie Gitterstruktur und Komponenten nach Ihren Wünschen aus.

Our innovative furnishing system is available in various heights and widths. Decide on a suitable size in portrait or landscape format and select the grid structure and components according to your requirements.

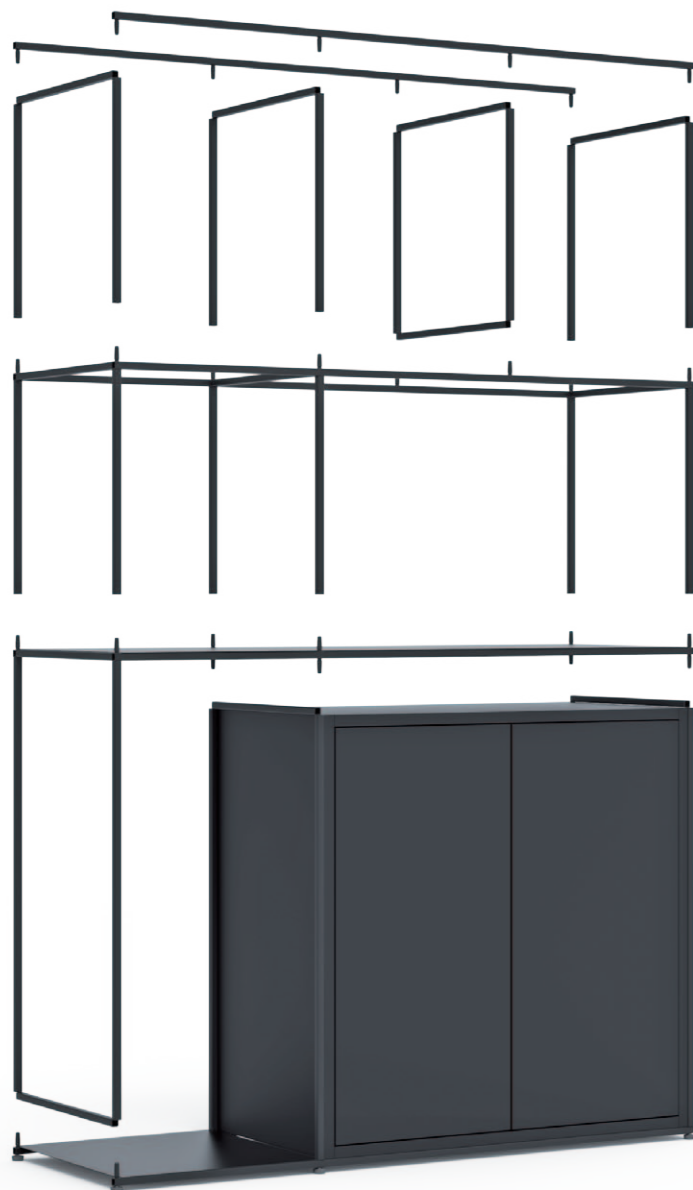

Längsstrebe
horizontal strut

L = 372 - 1812 mm



U-Rahmen
U-frame

H = 372 - 1452 mm

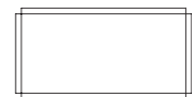

Vollrahmen
full frame

H = 192 - 372 mm

CAROLINE[®]

by [concept·s]

Einfacher und schneller Aufbau
ohne Spezial-Werkzeug dank
unserem patentierten Stecksystem

Quick and easy assembly without any
special tools thanks to our patented
plug-in system

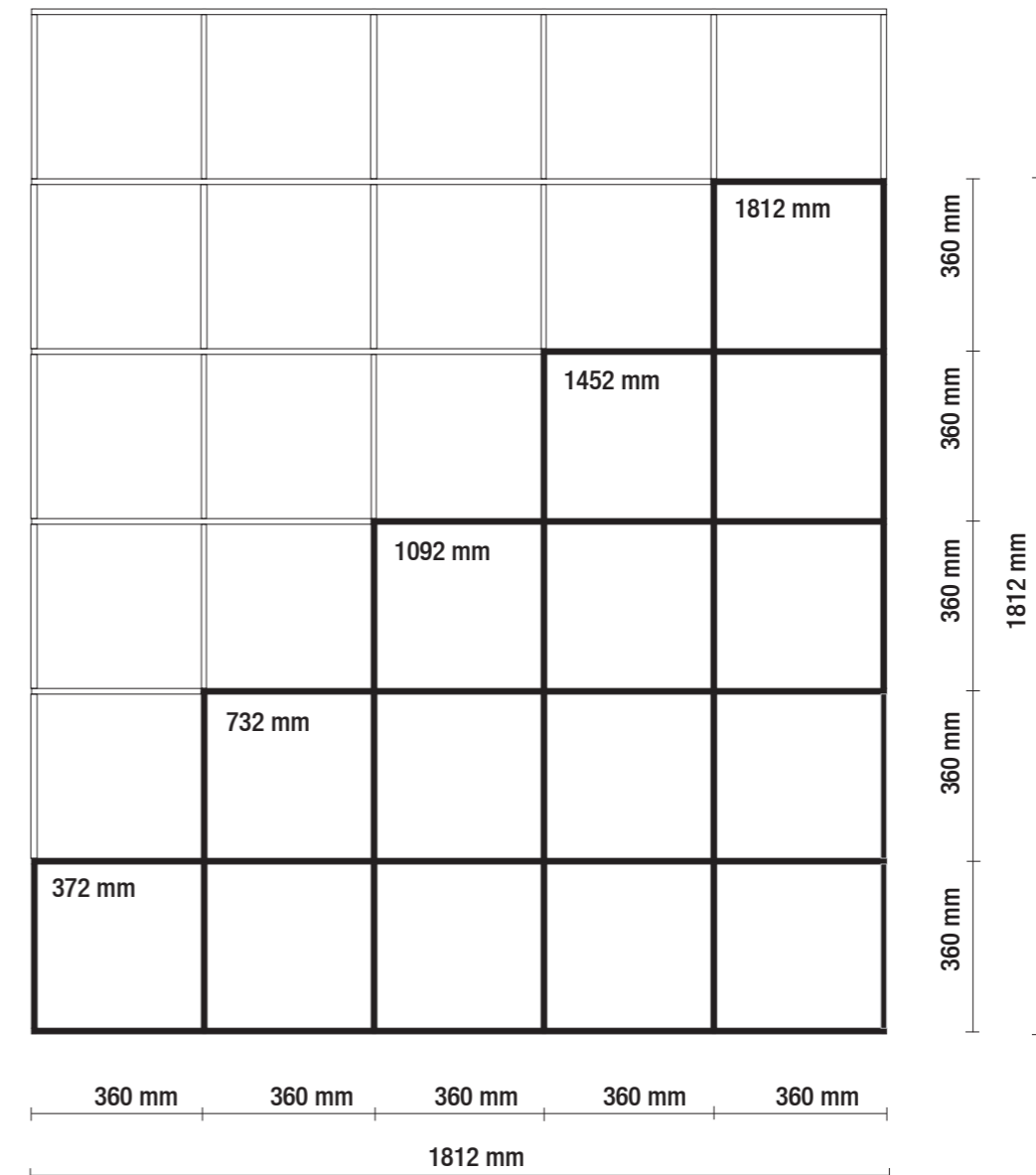

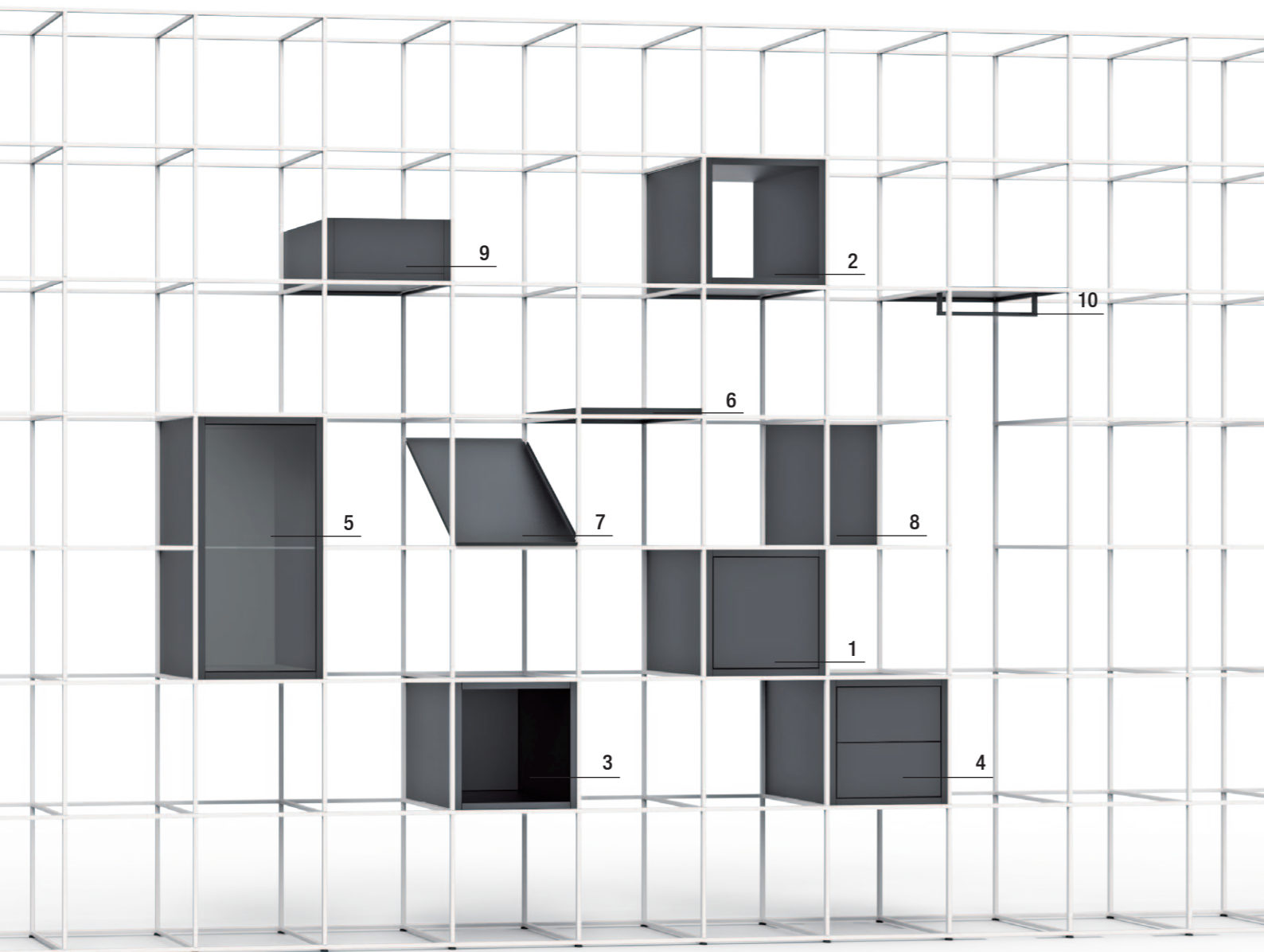

Aus der Kombination von Gitterstruktur und Komponenten ergeben sich unendlich viele Konfigurationen, die Sie stets nach Ihren Bedürfnissen anpassen und somit jedes Möbel zu Ihrem persönlichen Lieblingsstück machen können.

The combination of grid structure and components results in an infinite number of configurations that you can always adapt to your needs, making every furniture item your personal favourite.

- | | | | |
|----|----------------------|----|------------------------|
| 1 | Korpus mit Tür | 1 | corpus with door |
| 2 | offener Korpus | 2 | open corpus |
| 3 | Korpus mit Rückwand | 3 | corpus with back panel |
| 4 | Korpus mit Schublade | 4 | corpus with drawer |
| 5 | Korpus mit Glastür | 5 | corpus with glass door |
| 6 | Ablage | 6 | shelf |
| 7 | Schrägablage | 7 | inclined shelf |
| 8 | Rückwand | 8 | back panel |
| 9 | Pflanzbox | 9 | planter box |
| 10 | Kleiderstange | 10 | clothing rail |

Alle Komponenten wie Ablagen, Korpusse und sonstige Elemente werden ganz einfach an den gewünschten Positionen in der Regalstruktur eingesetzt.

All components such as shelves, corpuses and other elements are also simply inserted at the desired positions in the modular structure.

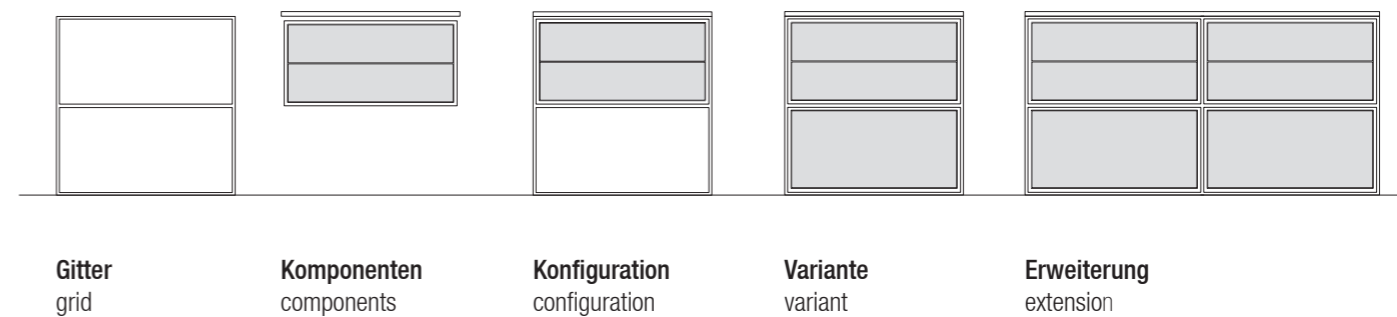

Konfigurator

configurator



Mit unserem kostenlosen CAROLINE HOME & LIVING Konfigurator können Sie Ihre eigenen Einrichtungsmöbel und Wunschausstattungen individuell zusammenstellen und mit einem Klick bestellen.

www.caroline-system.com/de/downloads

With our free CAROLINE HOME & LIVING configurator, you can put together your own customised furniture and features and order them with just one click.

www.caroline-system.com/en/downloads

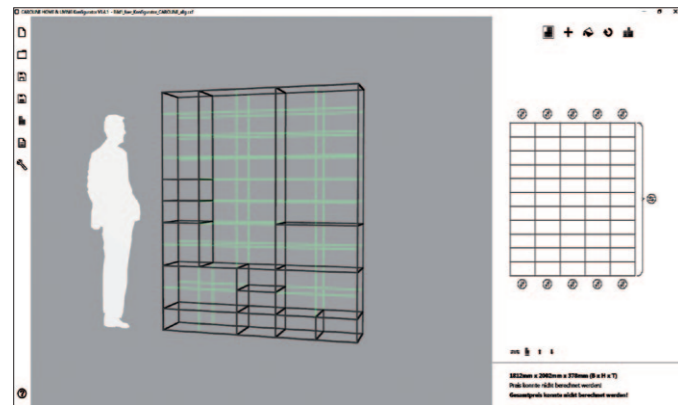

Gitterstruktur

grid structure



Gitterstruktur bearbeiten:

- Gitterstruktur in Höhe, Breite & Form festlegen
- direkte Aktualisierung von Dimensionen & Preisen bei Veränderung der Konfiguration

Edit grid structure:

- set grid structure in height, width & shape
- direct adjustment of dimensions & prices when configuration changes

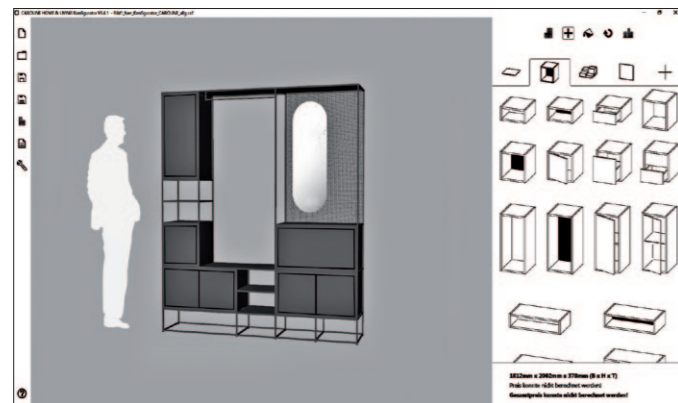

Komponenten

components



Komponenten hinzufügen/entfernen:

- aktuelle Konfiguration immer direkt als rotierbare 3D-Ansicht dargestellt
- alle Komponenten können nach Belieben per Drag & Drop eingesetzt werden

Add / remove components:

- current configuration always directly displayed as a rotatable 3D view
- all components can be placed as desired via drag & drop

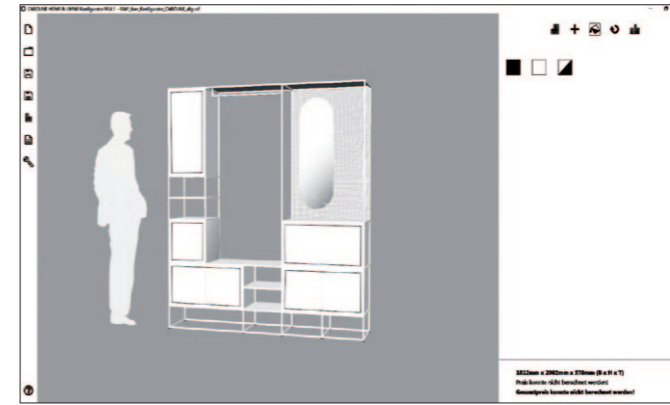

Farben

colours



Farben für Gitterstrukturen & Komponenten auswählen:

- alles weiß oder alles schwarz
- Farben invertieren

Select colours for grid structures & components:

- all white or all black
- invert colours

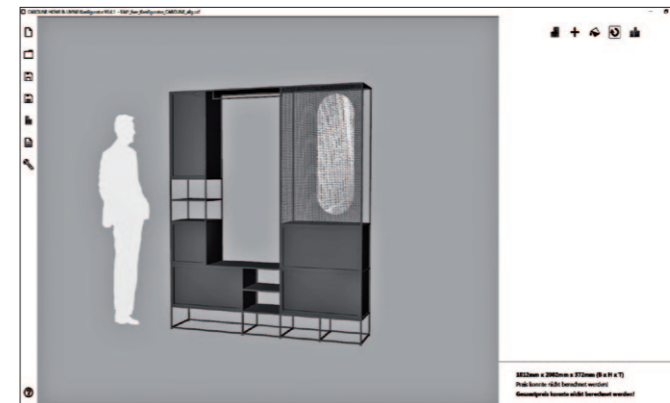

Drehen

rotate



Einzelne Komponenten drehen:

Klicken Sie in diesem Modus einzelne Komponenten in der 3D-Vorschau an, um ihre Ausrichtung zu wechseln (bei drehbaren Komponenten).

Rotate individual components:

Use this mode and click on individual components in the 3D preview to change their orientation (for rotatable components).



Kombinieren

combine



Bibliothek:

Aus der Bibliothek können Sie vordefinierte Module in die aktuelle Konfiguration einfügen und nach Belieben weiter bearbeiten.

Library:

You can add pre-defined modules from the library into the current configuration and edit them according to your preferences.

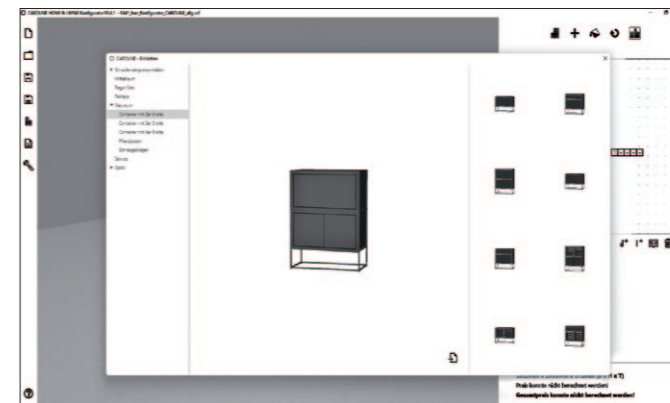

Bibliothek

library



Bibliothek:

Aus der Bibliothek können Sie vordefinierte Module in die aktuelle Konfiguration einfügen und nach Belieben weiter bearbeiten.

Library:

You can add pre-defined modules from the library into the current configuration and edit them according to your preferences.



Photo by Hrustal on Unsplash

12

Diele
hallway



24

Wohnen
living room



58

Schlafen
bedroom



76

Bad
bathroom



84

Küche
kitchen



92

Arbeiten
workplace



Diele
hallway

Photo by Uliana Koliasa on Unsplash

Kleiderstange
clothes rail

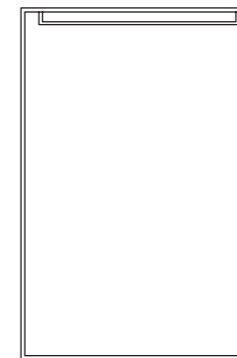

Spiegel
mirror

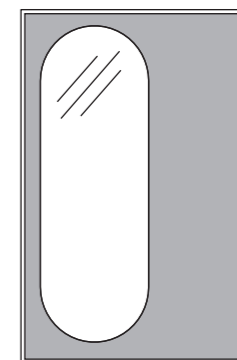

Stauraum
storage space

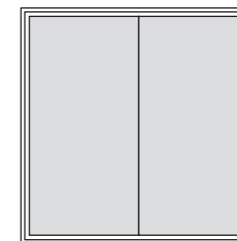

Schuhregal
shoe rack

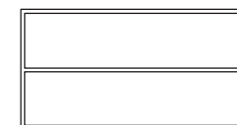

Garderobe

coat rack

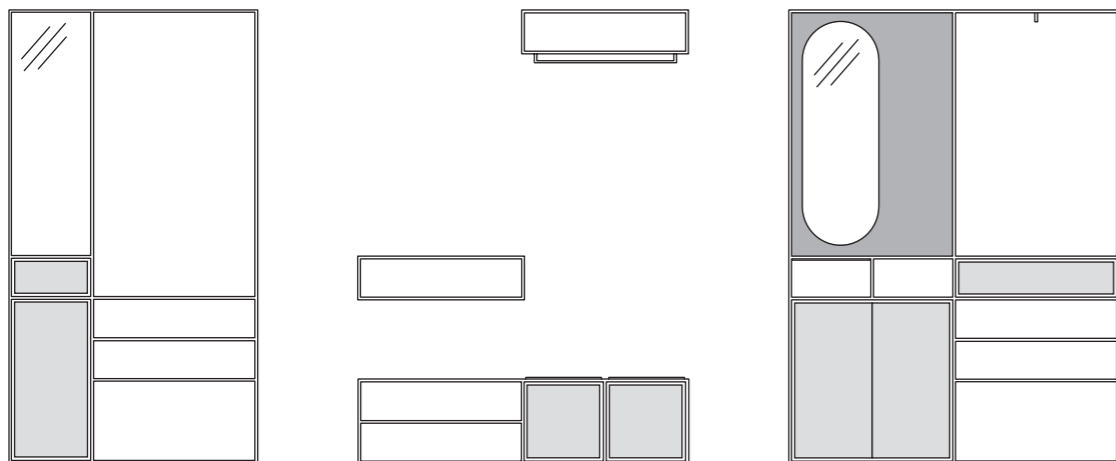
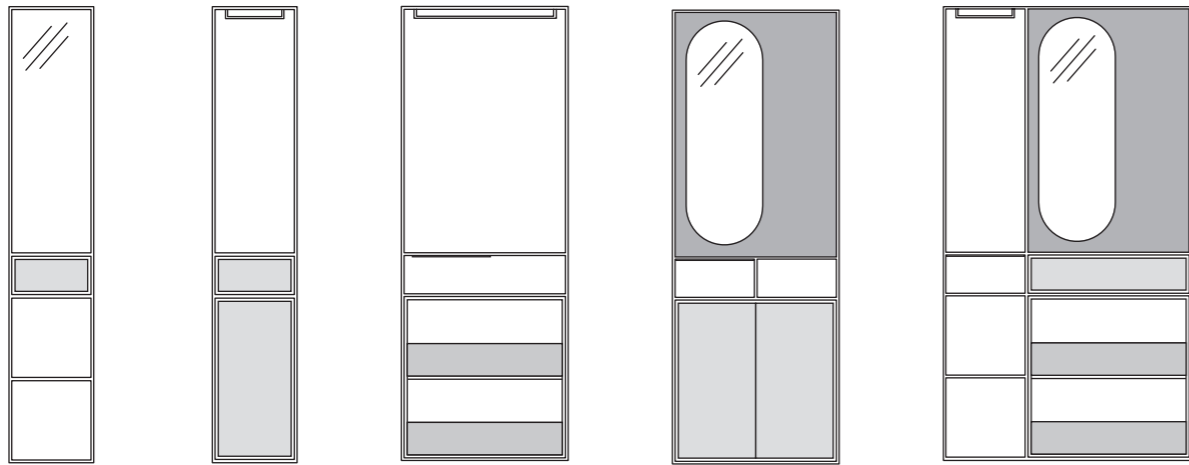

Im CAROLINE HOME & LIVING Konfigurator finden Sie alle hier abgebildeten Konfigurationen und können diese auch individuell anpassen und ausstatten. Garderoben sollten aufgrund ihrer Form und Größe an der Wand befestigt werden. Bitte kontaktieren Sie uns für weitere Informationen!

In the CAROLINE HOME & LIVING configurator you can find all the configurations shown here and can also customise and equip them individually. Coat racks should be attached to the wall due to their shape and size. Please contact us for further information!



Kleiderstange clothes rail

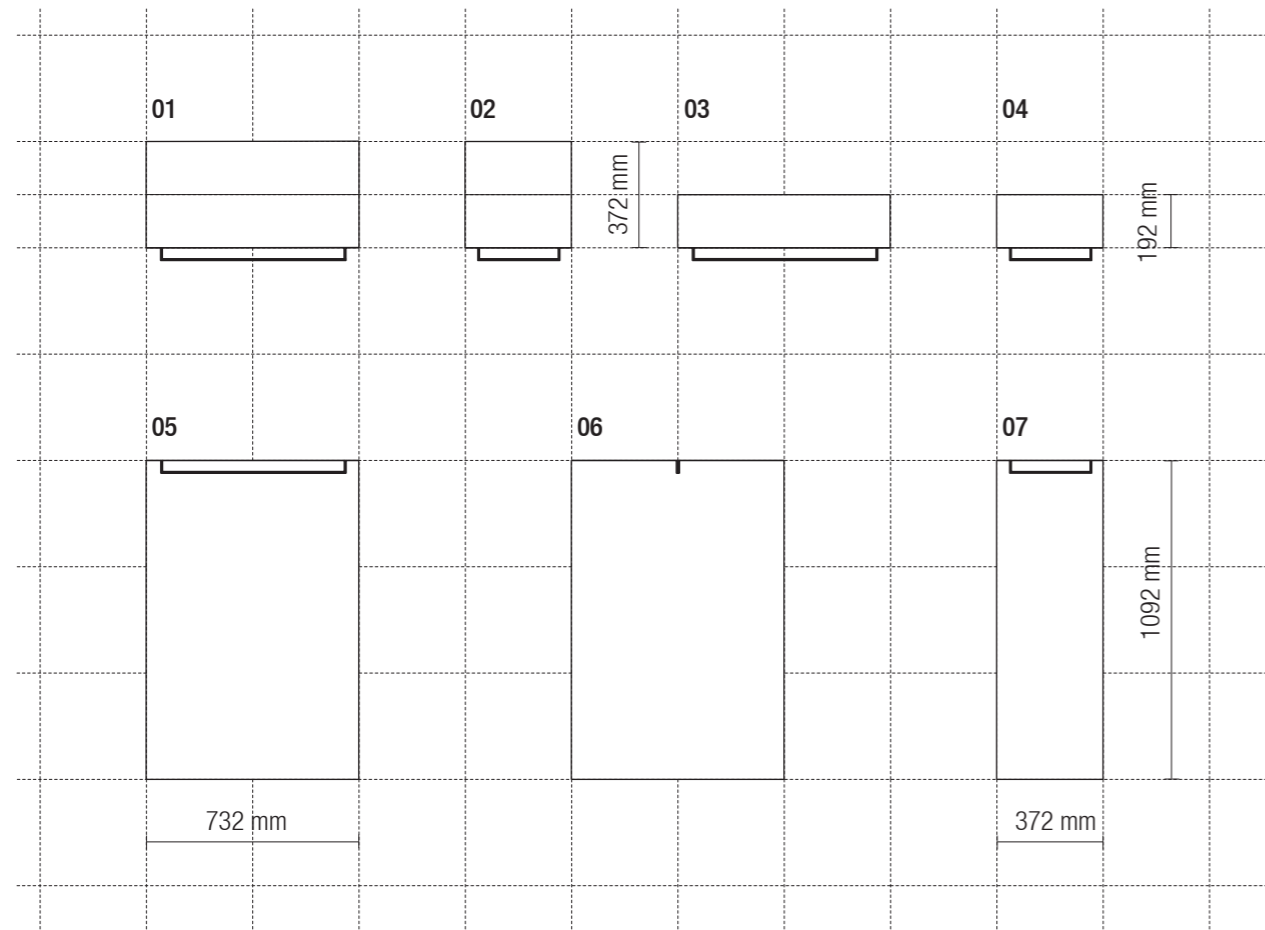

Spiegel mirror

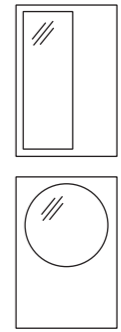
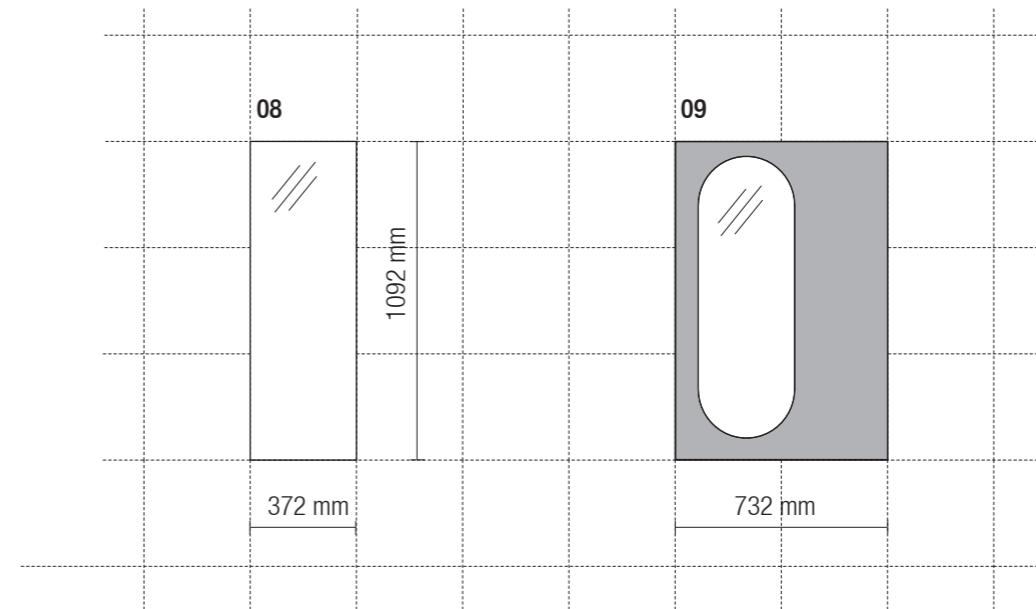

Varianten variants

Frontspiegel front mirror

Rückwand aus Lochblech mit Spiegel back panel made of perforated metal with mirror

Schuhregal shoe rack

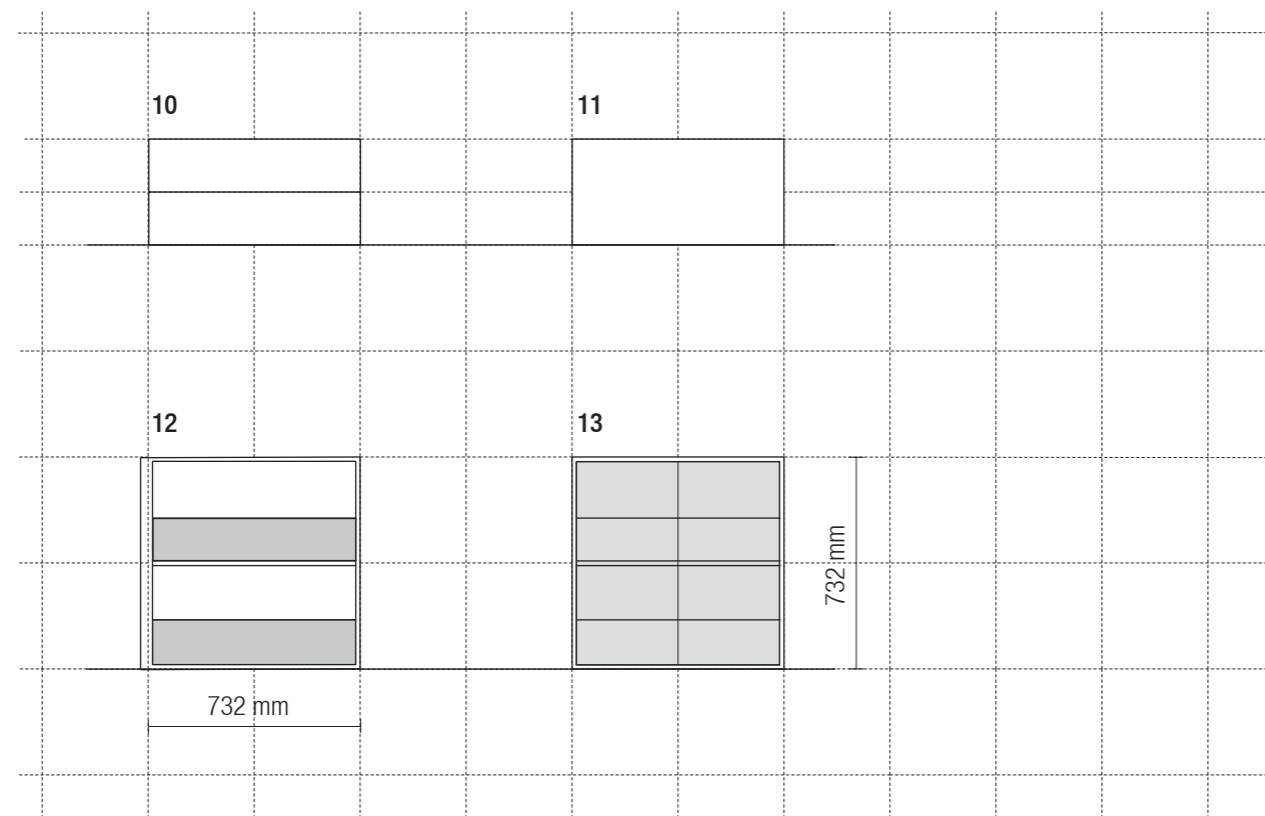

Sonstiges miscellaneous

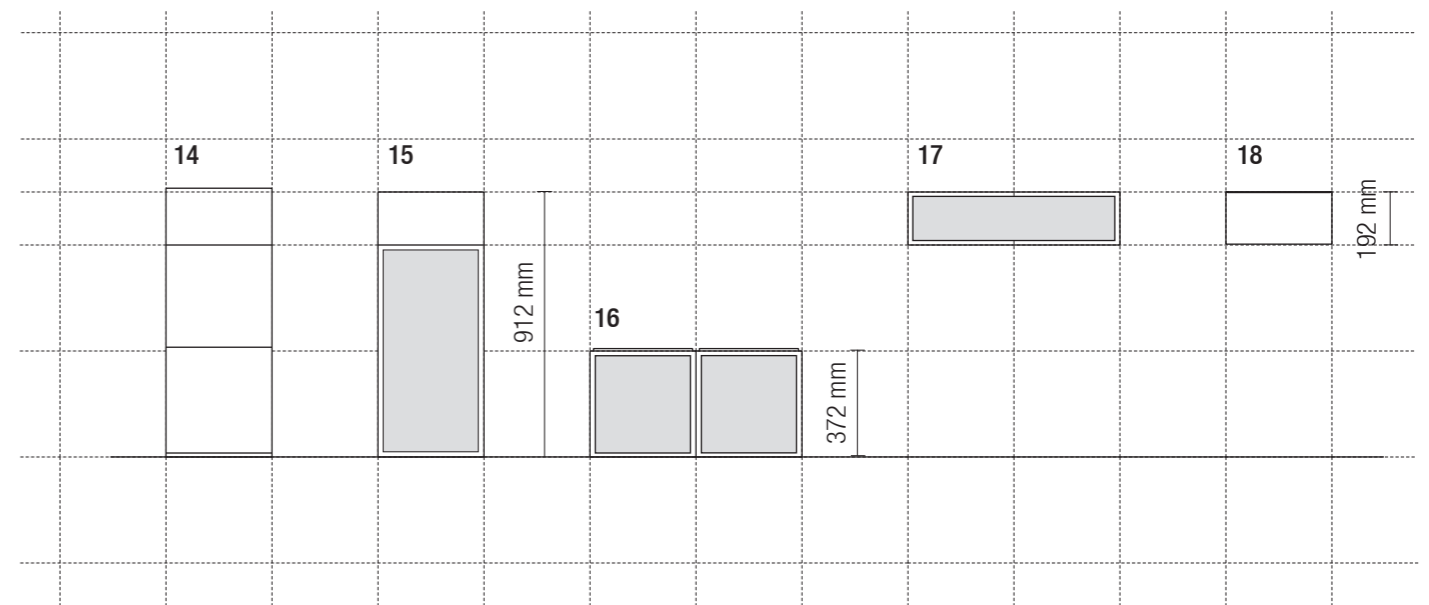

Stauraummodule storage space units

Sitzbank seat

Stauraummodul storage space unit

Ablagetablar valet tray

Module modules

Garderobe

coat rack

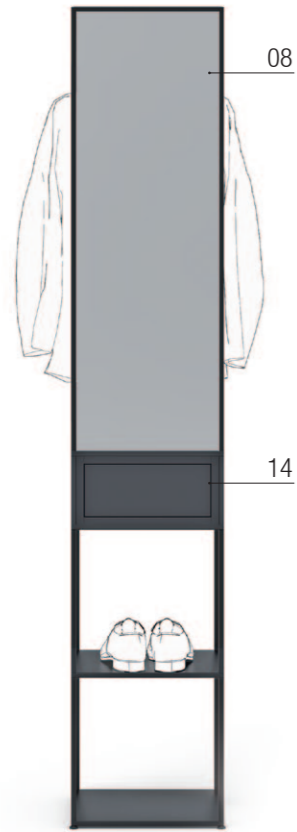

1a

Garderobe coat rack 1a bb · 1 x 5.5
372 x 2002 x 372 mm

Kleiderstange · Frontspiegel · Korpus
mit Schublade · Metallablagen
clothes rail · front mirror · corpus
with drawer · metal shelves

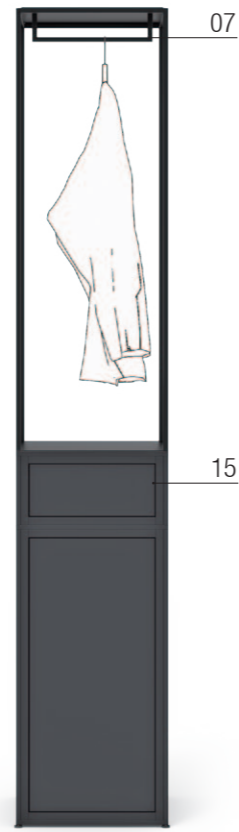

2a

Garderobe coat rack 2a bb · 1 x 5.5
372 x 2002 x 372 mm

Kleiderstange · Metallablage · Korpus
mit Schublade · Korpus mit Tür
clothes rail · metal shelf · corpus
with drawer · corpus with door

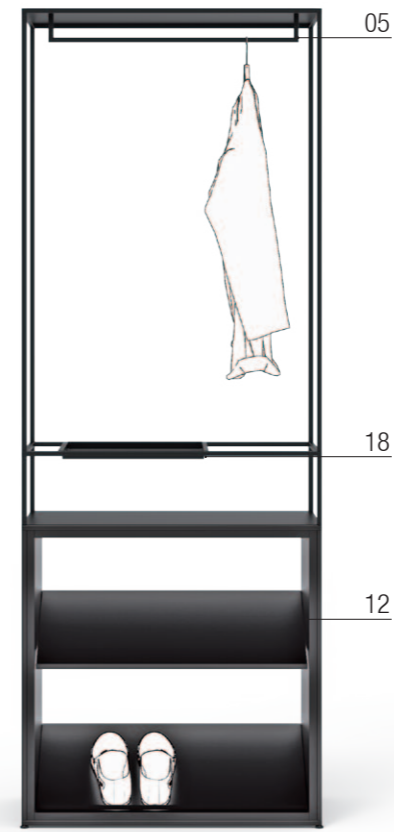

3a

Garderobe coat rack 3a bb · 2 x 5.5
732 x 2002 x 372 mm

Kleiderstange · Ablagetablar ·
Metallablage · Schuhregal
clothes rail · valet tray · metal shelf ·
shoe rack

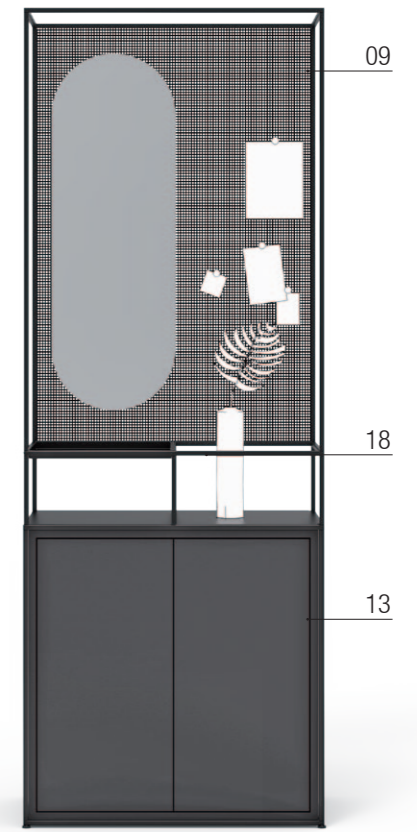

4a

Garderobe coat rack 4a bb · 2 x 5.5
732 x 2002 x 372 mm

Rückwand mit Spiegel · Ablagetablar ·
Metallablage · Schuhschrank
back panel with mirror · valet tray ·
metal shelf · shoe cabinet

Varianten variants

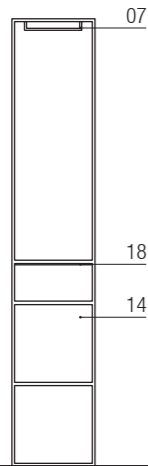

1b

372 x 2002 x 372 mm

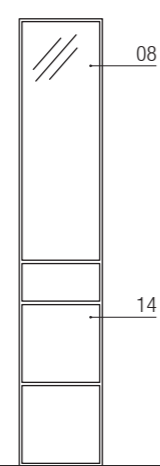

1c

372 x 2002 x 372 mm

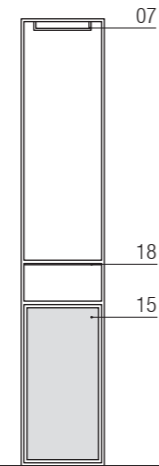

2b

372 x 2002 x 372 mm

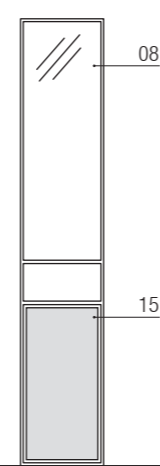

2c

372 x 2002 x 372 mm

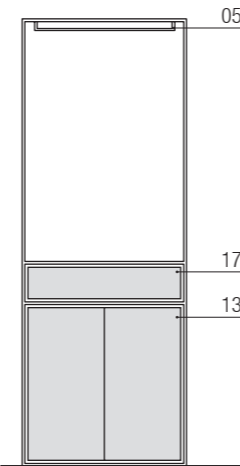

3b

732 x 2002 x 372 mm

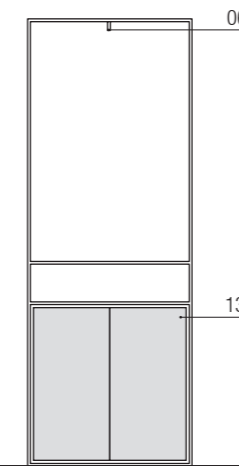

3c

732 x 2002 x 372 mm

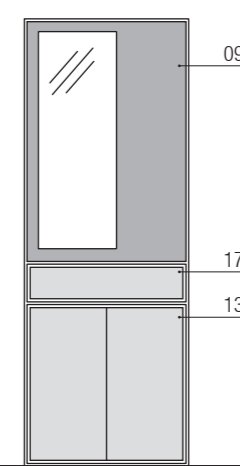

4b

732 x 2002 x 372 mm

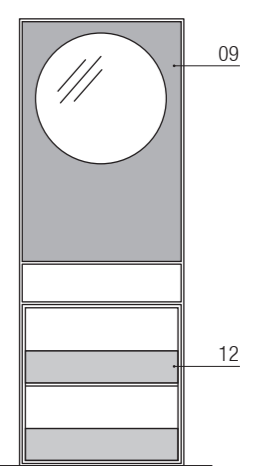

4c

732 x 2002 x 372 mm

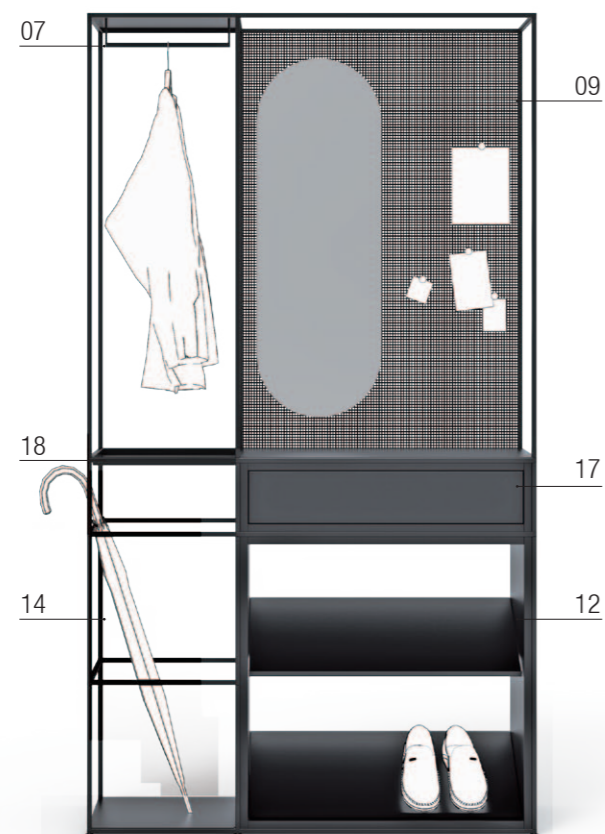

5a

Garderobe coat rack 5a bb · 3 x 5.5
1092 x 2002 x 372 mm

Kleiderstange · Ablagetablar · Metallablage · Rückwand mit Spiegel · Korpus mit Schublade · Schuhregal
clothes rail · valet tray · metal shelf · back panel with mirror · corpus with drawer · shoe rack

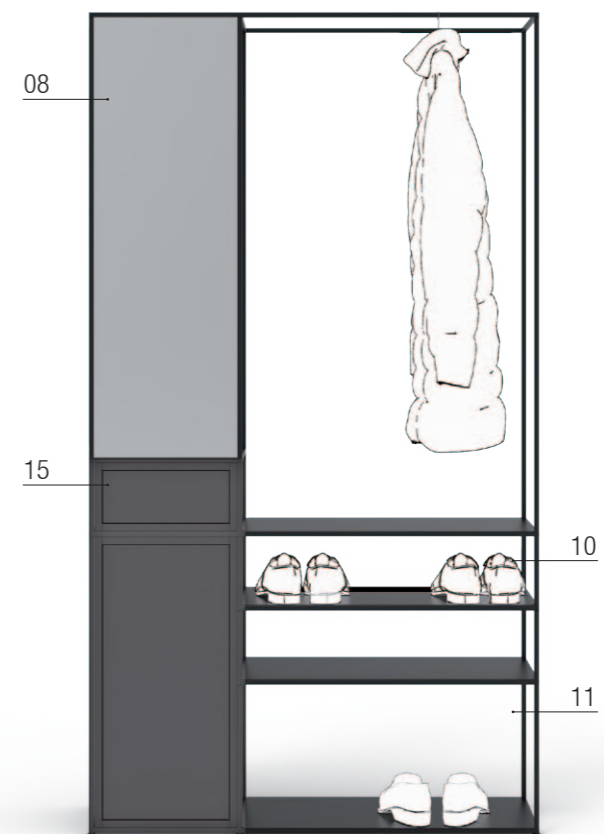

6a

Garderobe coat rack 6a bb · 3 x 5.5
1092 x 2002 x 372 mm

Frontspiegel · Korpus mit Schublade · Korpus mit Tür · Längsstrebe als Kleiderstange · Metallablagen
front mirror · corpus with drawer · corpus with door · horizontal strut as clothes rail · metal shelves

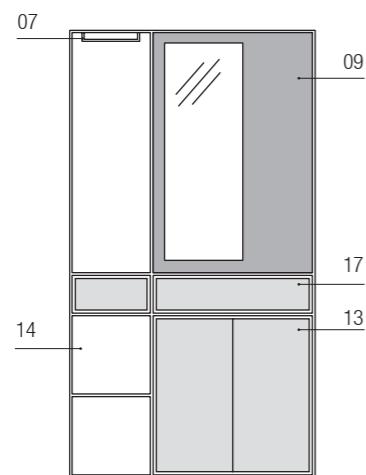

5b

1092 x 2002 x 372 mm

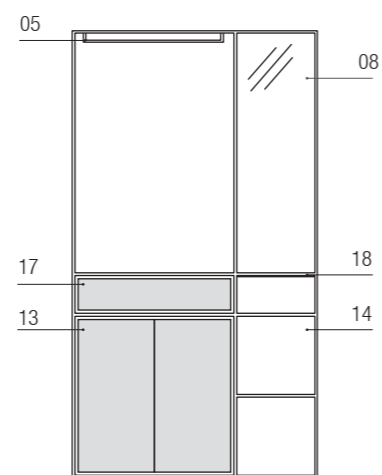

5c

1092 x 2002 x 372 mm

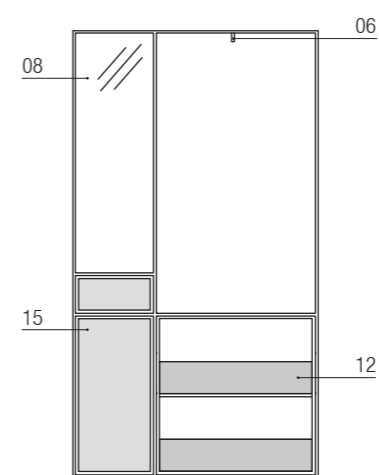

6b

1092 x 2002 x 372 mm

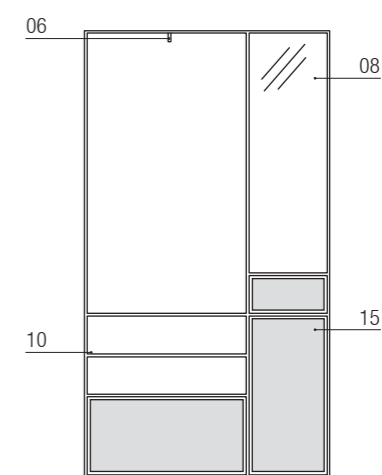

6c

1092 x 2002 x 372 mm

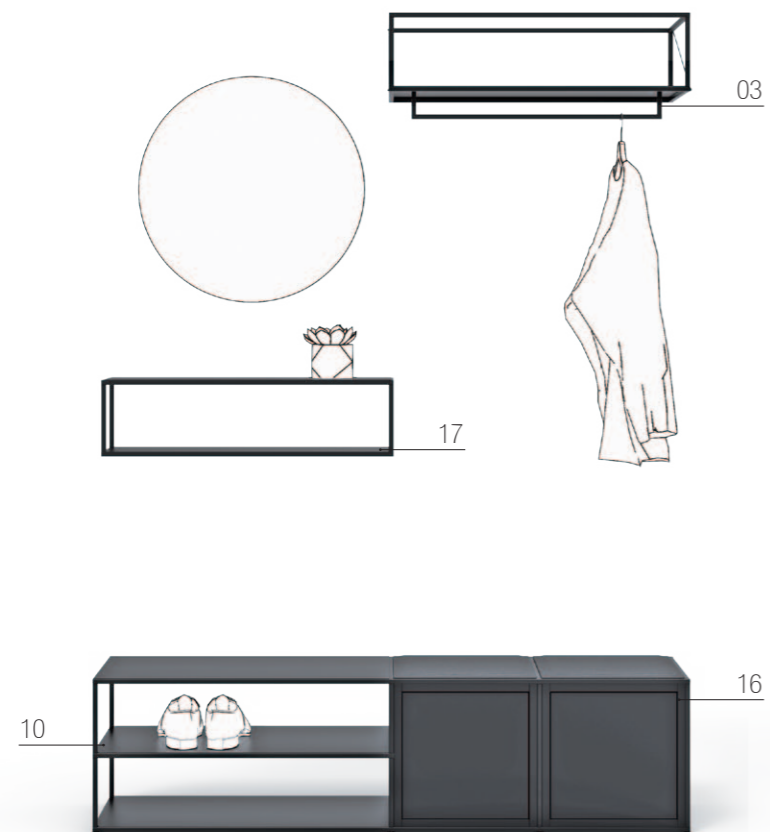

7a

Garderobe coat rack 7a bb
1452 x 2002 x 372 / 192 mm

Kleiderstange · Hängeregal · Metallablagen · Sitzbank
clothes rail · hanging shelf · metal shelves · seat

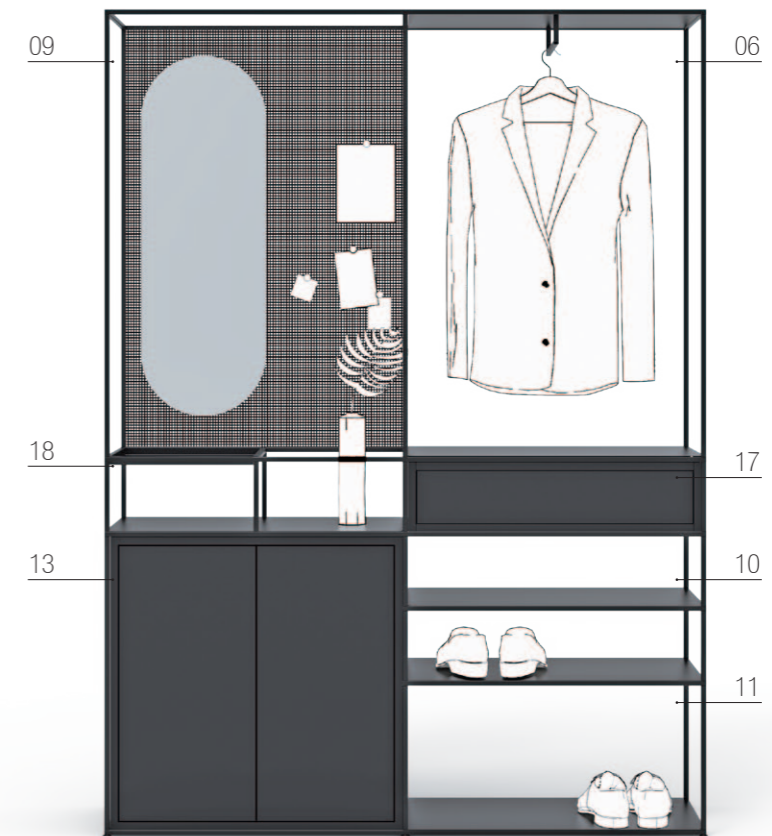

8a

Garderobe coat rack 8a bb · 4 x 5.5
1452 x 2002 x 372 mm

Rückwand mit Spiegel · Metallablagen · Ablagetablet · Schuhschrank · Kleiderstange · Korpus mit Schublade
back panel with mirror · metal shelves · valet tray · shoe cabinet · clothes rail · corpus with drawer

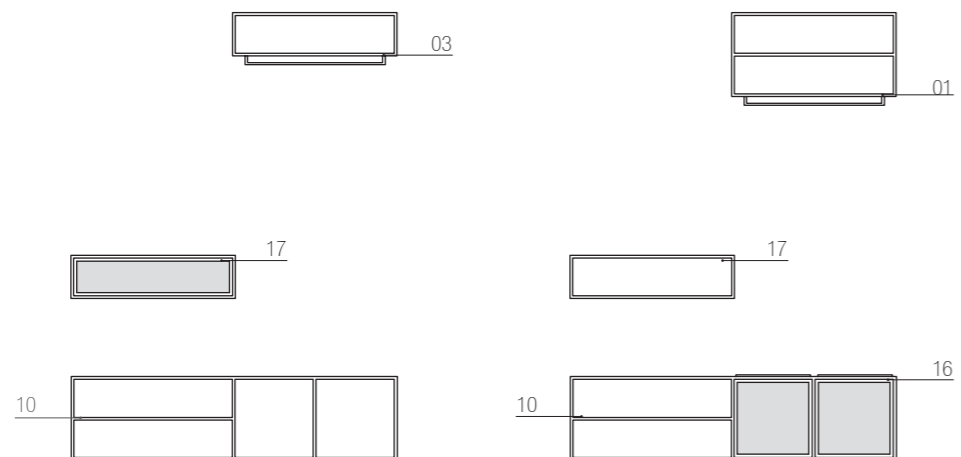

7b
1452 x 2002 x 372 / 192 mm

7c
1452 x 2002 x 372 / 192 mm

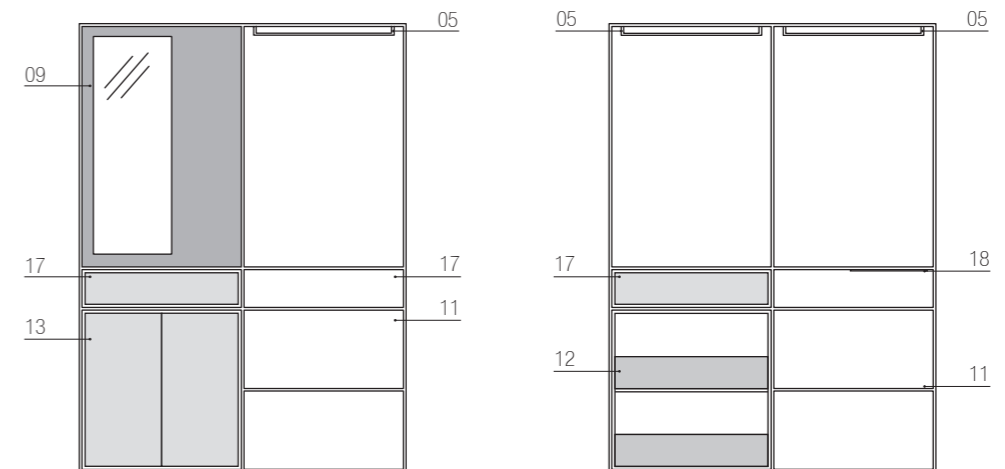

8b
1452 x 2002 x 372 mm

8c
1452 x 2002 x 372 mm



Wohnen

living

Photo by Javier Miranda on Unsplash

Kleinmöbel
small furniture

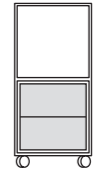

Stauraummöbel
storage furniture

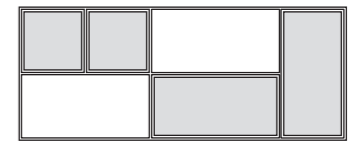

Regal
shelving unit

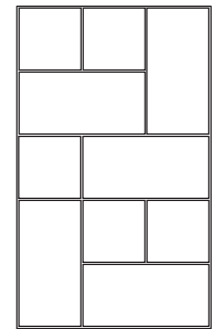

Wohnwand
wall unit

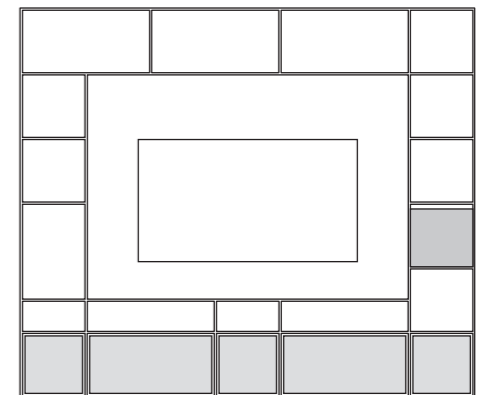

Trolley

trolley

Beistelltisch

side table



1a

Trolley trolley 1a bb · 1 x 2
384 x 798 x 372 mm

Top-Platte · Metallablage ·
Korpus mit Schubladen · Rollen
top plate · metal shelf · corpus with
drawers · castors



1b

Trolley trolley 1b bw · 1 x 2
372 x 798 x 372 mm

Top-Platte · Korpus offen · Korpus
mit Schublade · Rollen
top plate · open corpus · corpus with
drawer · castors



1a

Beistelltisch side table 1a bb · 1 x 1.5
372 x 562 x 372 mm

Top-Platte aus Glas · Metallablage
top plate made of glass · metal shelf



1b

Beistelltisch side table 1b bw · 1 x 1.5
372 x 562 x 372 mm

Top-Platte · Korpus mit Tür
top plate · corpus with door

Konfigurationen configurations

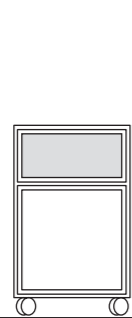

2

384 x 798 x 372 mm

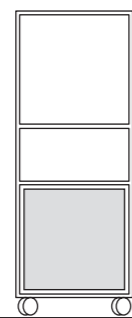

3

384 x 798 x 372 mm

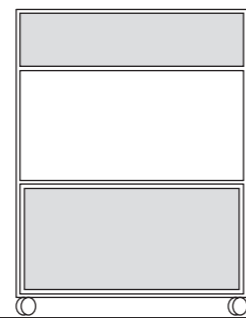

4

732 x 978 x 372 mm



2

372 x 562 x 372 mm



3

372 x 742 x 372 mm



4

372 x 742 x 372 mm

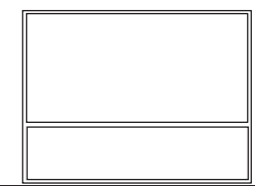

5

732 x 562 x 372 mm

Couchtisch

coffee table

Café-Bar

coffee bar

Konfigurationen configurations



erhältlich mit einfacher Tiefe (372 mm)
oder doppelter Tiefe (744 mm)

available with single depth (372 mm)
or double depth (744 mm)



1a

Couchtisch coffee table 1a bb · 3 x 1
1092 x 382 x 372 / 744 mm

Top-Platte aus Glas · Metallablagen
top plate made of glass · metal shelves



Variante
variation

1b

1092 x 382 x 744 mm



1

Café-Bar coffee bar 1 bb · 3 x 5.5
1092 x 2002 x 372 mm

Metallablagen · Rückwand · Korpus mit
Schublade · Korpus mit Glastür · Korpus mit Tür
metal shelves · back panel · corpus with drawer ·
corpus with glass door · corpus with door

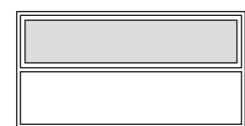

2

732 x 382 x 372 / 744 mm

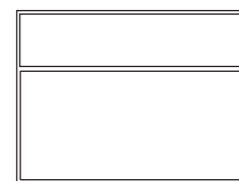

3

732 x 562 x 372 / 744 mm

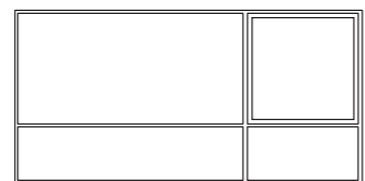

4

1092 x 562 x 372 / 744 mm

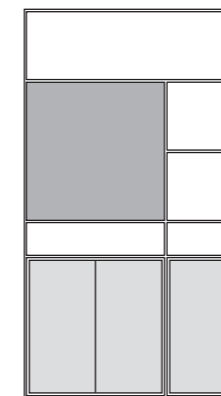

2

1092 x 2002 x 372 mm

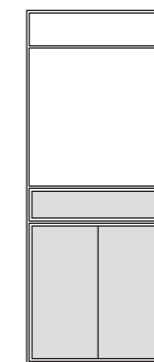

3

732 x 1822 x 372 mm



4

732 x 2002 x 372 mm

Barschrank

bar cabinet



1

Barschrank bar cabinet 1 ww · 2 x 4.5
732 x 1642 x 372 mm

Korpus mit Spiegel-Rückwand & Fachboden · Korpus mit Schublade
corpus with mirror back panel & shelf · corpus with drawer

Konfigurationen configurations



2
732 x 1282 x 372 mm



3
732 x 1822 x 372 mm

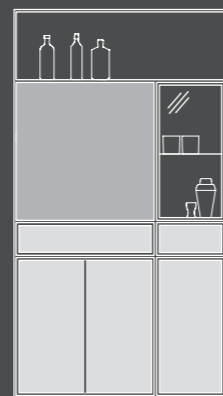

4
1092 x 2002 x 372 mm

Barschrank bar cabinet
3 ww · 2 x 4.5



TV-Board

tv board

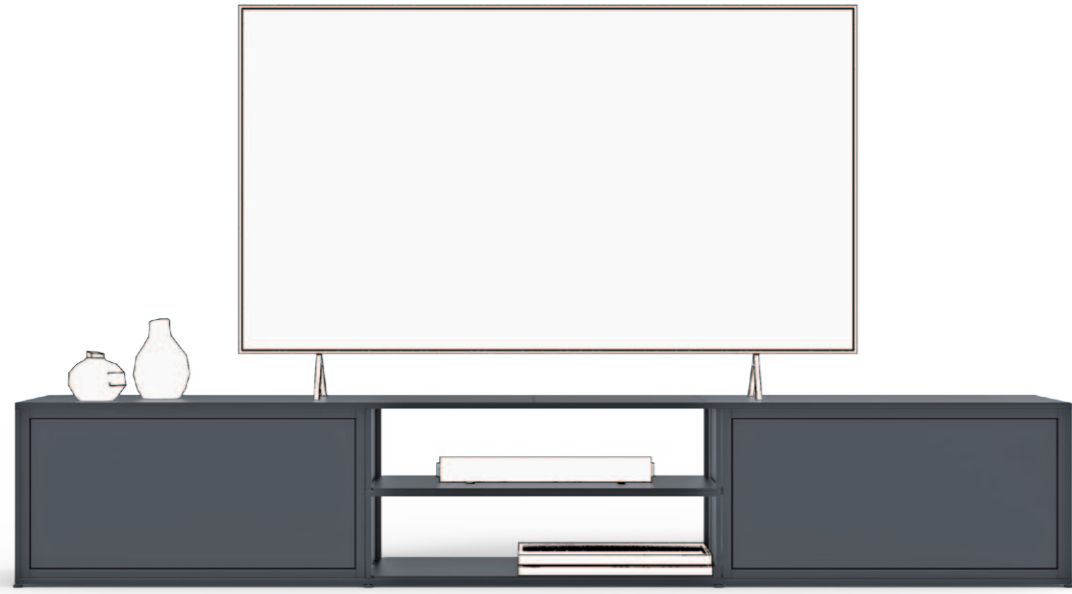

1

TV-Board tv board 1 bb · 6 x 1
2172 x 382 x 372 mm

Top-Platten · Korpus mit Schublade · Metallablagen
top plates · corpus with drawer · metal shelves



Varianten variants



2

1812 x 382 x 372 mm

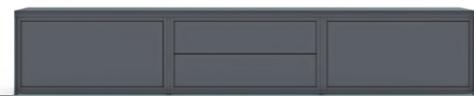

3

2172 x 382 x 372 mm

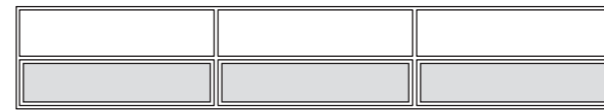

4

2172 x 382 x 372 mm

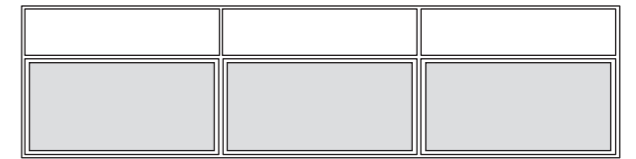

5

2172 x 562 x 372 mm

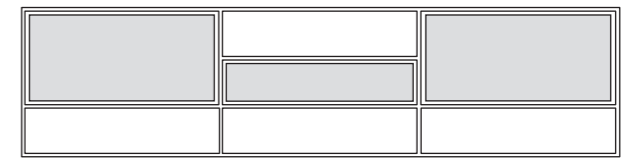

6

2172 x 562 x 372 mm

Sideboard

sideboard



1a

Sideboard sideboard 1a bb · 5 x 2
1812 x 742 x 372 mm

Top-Platten · Korpus mit Türen · Dekorablage ·
Korpus mit Schublade · Korpus mit Tür
top plates · corpus with drawer · wooden decor shelf ·
corpus with drawer · corpus with door

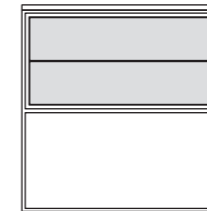

2
732 x 742 x 372 mm

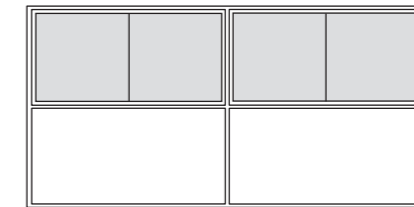

3
1452 x 742 x 372 mm

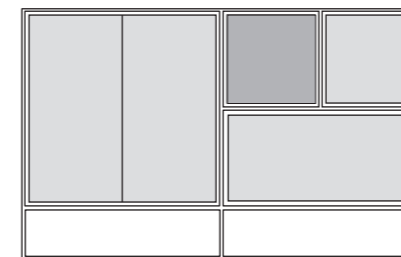

4
1452 x 922 x 372 mm

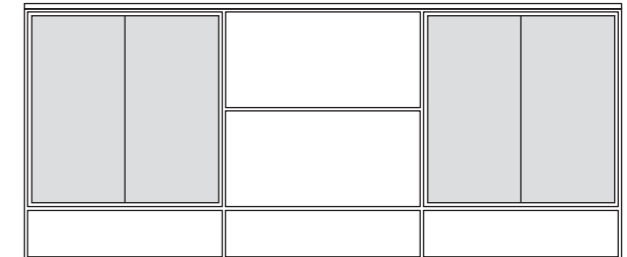

5
2172 x 922 x 372 mm

Varianten variants



1b
1812 x 742 x 372 mm

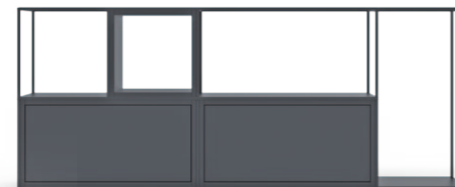

1c
1812 x 742 x 372 mm

Im CAROLINE HOME & LIVING Konfigurator finden Sie alle hier abgebildeten Konfigurationen und können diese auch individuell anpassen und ausstatten. Einige Module sollten aufgrund ihrer Form und Größe an der Wand befestigt werden, um ein Kippen zu vermeiden. Bitte kontaktieren Sie uns für weitere Informationen!

In the CAROLINE HOME & LIVING configurator you can find all the configurations shown here and can also customise and equip them individually. Due to their shape and size, some modules should be fixed to the wall to prevent them from tipping over. Please contact us for further information!

Lowboard

low board



1a

Lowboard low board 1a bb · 6 x 1.5
2172 x 562 x 372 mm

Top-Platten · Korpus mit Türen · Metallablage · Korpus mit Schublade
top plates · corpus with drawer · metal shelf · corpus with drawer



Varianten variants



1b

2172 x 562 x 372 mm

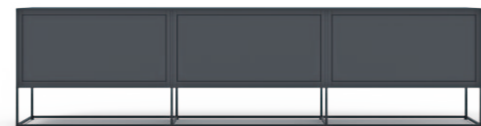

2

2172 x 562 x 372 mm

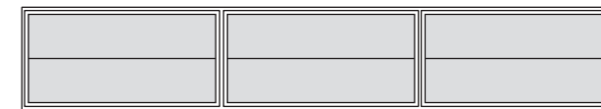

3

2172 x 382 x 372 mm

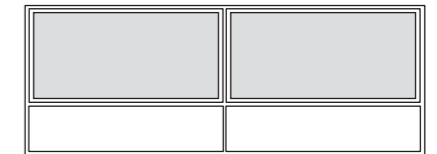

4

1452 x 562 x 372 mm



5

2172 x 562 x 372 mm

Kommode

chest of drawers

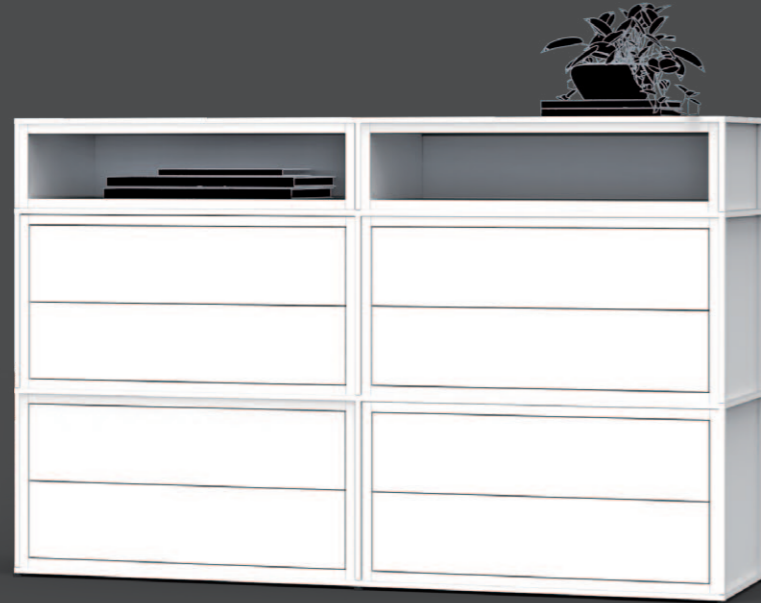

1a

Kommode chest of drawers 1a ww · 4 x 2.5
1452 x 922 x 372 mm

Top-Platten · Korpus mit Rückwand · Korpus mit Schubladen
top plates · corpus with back panel · corpus with drawers



2

1092 x 742 x 372 mm



3

1452 x 742 x 372 mm

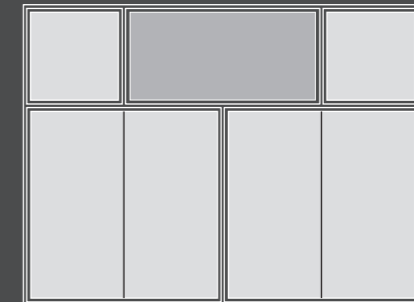

4

1452 x 1102 x 372 mm

Varianten variants

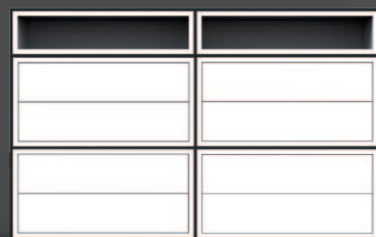

1b

1452 x 922 x 372 mm



1c

1452 x 922 x 372 mm

Im CAROLINE HOME & LIVING Konfigurator finden Sie alle hier abgebildeten Konfigurationen und können diese auch individuell anpassen und ausstatten. Einige Module sollten aufgrund ihrer Form und Größe an der Wand befestigt werden, um ein Kippen zu vermeiden. Bitte kontaktieren Sie uns für weitere Informationen!

In the CAROLINE HOME & LIVING configurator you can find all the configurations shown here and can also customise and equip them individually. Due to their shape and size, some modules should be fixed to the wall to prevent them from tipping over. Please contact us for further information!

Highboard

high board



1a

Highboard high board 1a bb · 3 x 3.5
1092 x 1282 x 372 mm

Top-Platten · Korpus mit Rückwand ·
Korpus mit Tür · Korpus mit Türen
top plates · corpus wit back panel ·
corpus with door · corpus with doors



Varianten variants



1b
1092 x 1282 x 372 mm

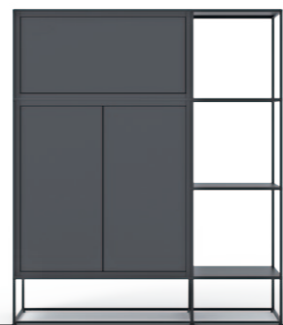

1c
1092 x 1282 x 372 mm

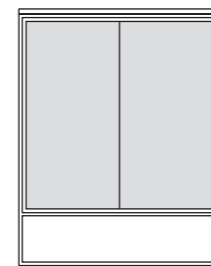

2
732 x 922 x 372 mm



3
732 x 1102 x 372 mm

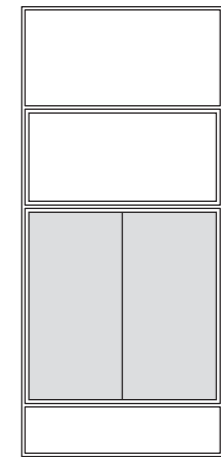

4
732 x 1642 x 372 mm

Regal & Raumteiler

shelving unit & room divider



1a

Regal shelving unit 1a bb · 3 x 5
1092 x 1822 x 372 mm

Metallablagen
metal shelves

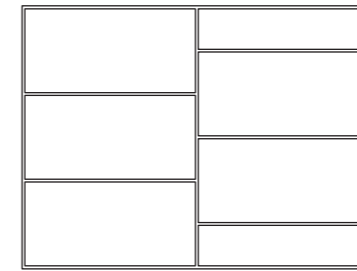

2
1452 x 1102 x 372 mm

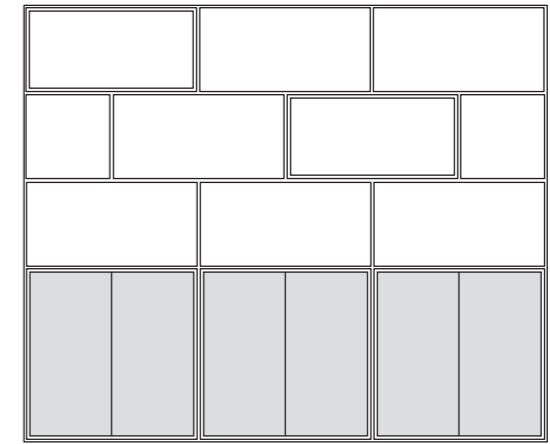

4
2172 x 1822 x 372 mm

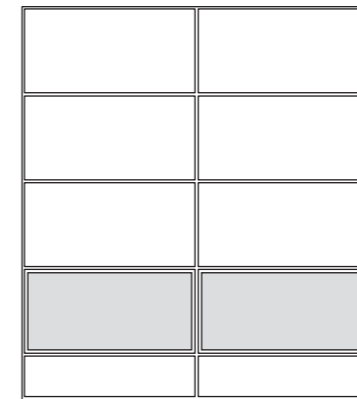

3
1452 x 1642 x 372 mm

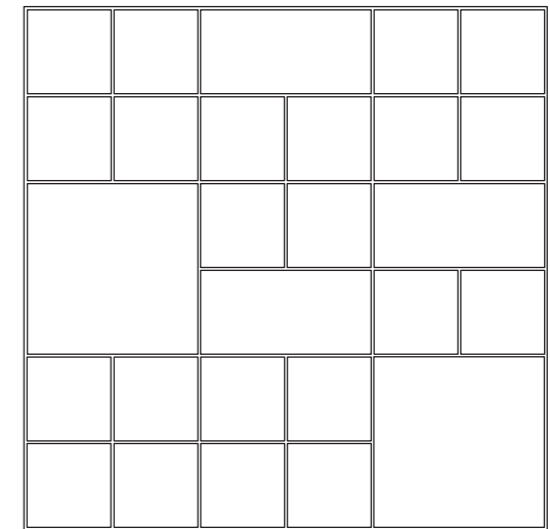

5
2172 x 2182 x 372 mm



1b
1092 x 1822 x 372 mm



1c
1092 x 1822 x 372 mm

Varianten variants

Im CAROLINE HOME & LIVING Konfigurator finden Sie alle hier abgebildeten Konfigurationen und können diese auch individuell anpassen und ausstatten. Regale und Raumteiler sollten aufgrund ihrer Form und Größe an der Wand, dem Boden oder der Decke befestigt werden. Bitte kontaktieren Sie uns für weitere Informationen!

In the CAROLINE HOME & LIVING configurator you can find all the configurations shown here and can also customise and equip them individually. Shelves and room dividers should be attached to the wall, floor or ceiling due to their shape and size. Please contact us for further information!

Wandregal & Schallplattenregal

wall rack & record shelf

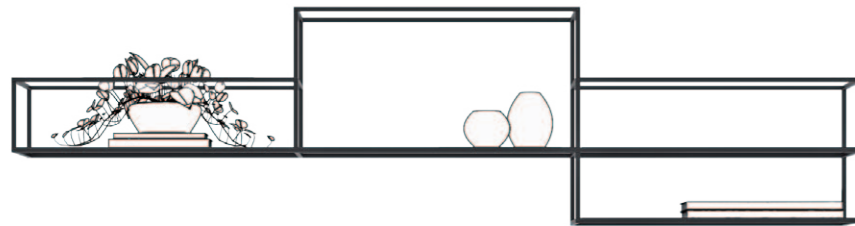

1

Wandregal wall rack
1 bb · 6 x 1.5
2172 x 552 x 372 mm

Metallablagen
metal shelves



5a

Schallplattenregal record shelf
5a bb · 6 x 2.5
2172 x 922 x 372 mm

Top-Platten · Seitenwände · Metallablagen · Rückwände · Schrägablage
top plates · side panel · metal shelves · back panels · inclined shelf



2

1452 x 372 x 372 mm



3

1452 x 192 x 192 mm



4

372 x 372 x 372 mm

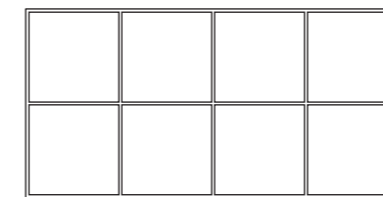

6

1452 x 732 x 372 mm



7

732 x 922 x 372 mm

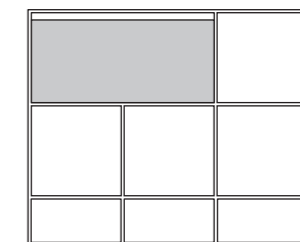

8

1092 x 922 x 372 mm

Varianten variants



5b

2172 x 922 x 372 mm

Im CAROLINE HOME & LIVING Konfigurator finden Sie alle hier abgebildeten Konfigurationen und können diese auch individuell anpassen und ausstatten. Einige Module sollten aufgrund ihrer Form und Größe an der Wand befestigt werden, um ein Kippen zu vermeiden. Bitte kontaktieren Sie uns für weitere Informationen!

In the CAROLINE HOME & LIVING configurator you can find all the configurations shown here and can also customise and equip them individually. Due to their shape and size, some modules should be fixed to the wall to prevent them from tipping over. Please contact us for further information!

Alle Maßangaben in mm. Reihenfolge: Breite x Höhe x Tiefe
All dimensions in mm, order: width x height x depth



Highboard high board 1a ww · 3 x 3.5

Wohnwand

wall unit

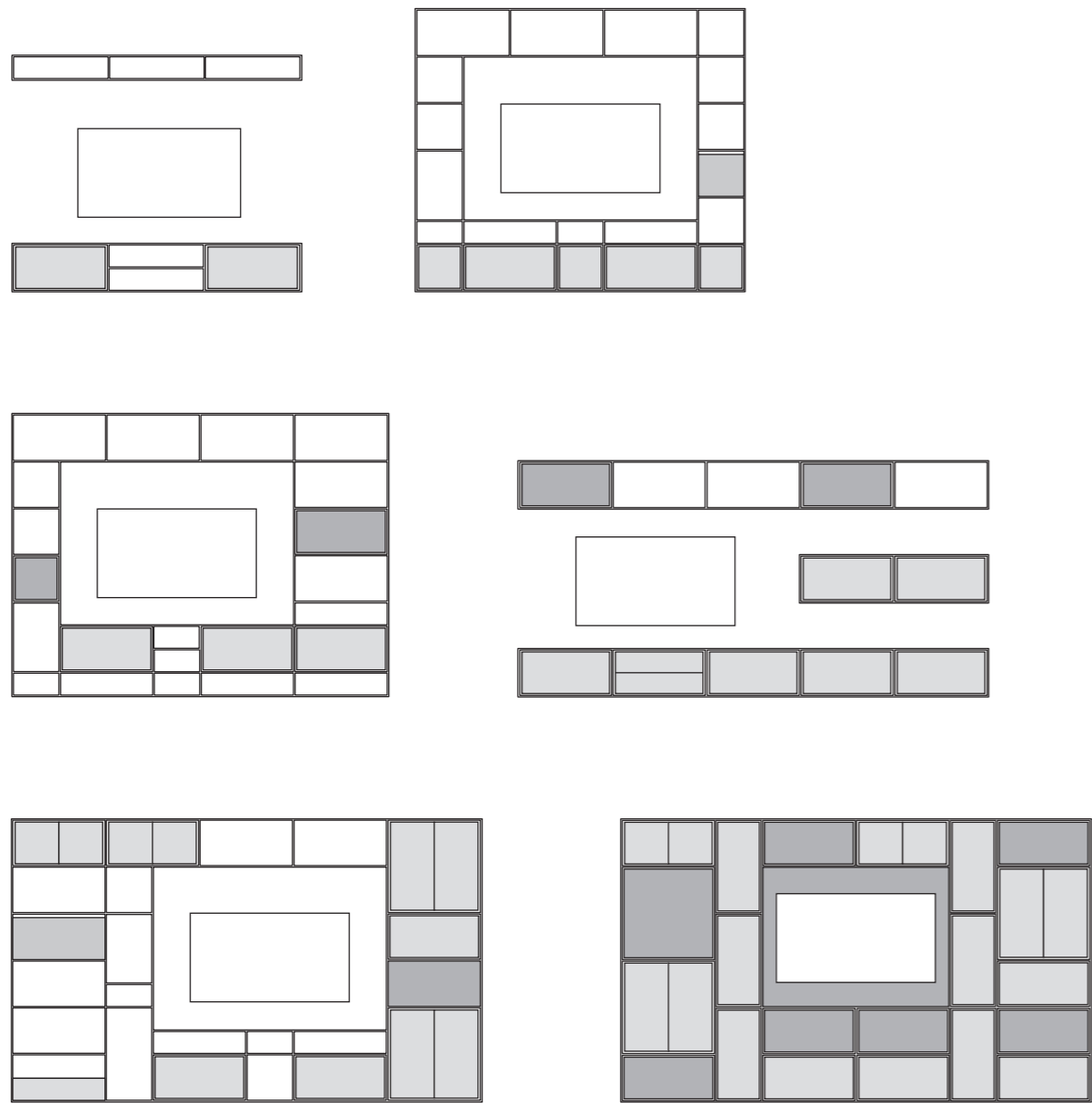

Im CAROLINE HOME & LIVING Konfigurator finden Sie alle hier abgebildeten Konfigurationen und können diese auch individuell anpassen und ausstatten. Einige Module sollten aufgrund ihrer Form und Größe an der Wand befestigt werden, um ein Kippen zu vermeiden. Bitte kontaktieren Sie uns für weitere Informationen!

In the CAROLINE HOME & LIVING configurator you can find all the configurations shown here and can also customise and equip them individually. Due to their shape and size, some modules should be fixed to the wall to prevent them from tipping over. Please contact us for further information!



Hängeregal hanging shelf

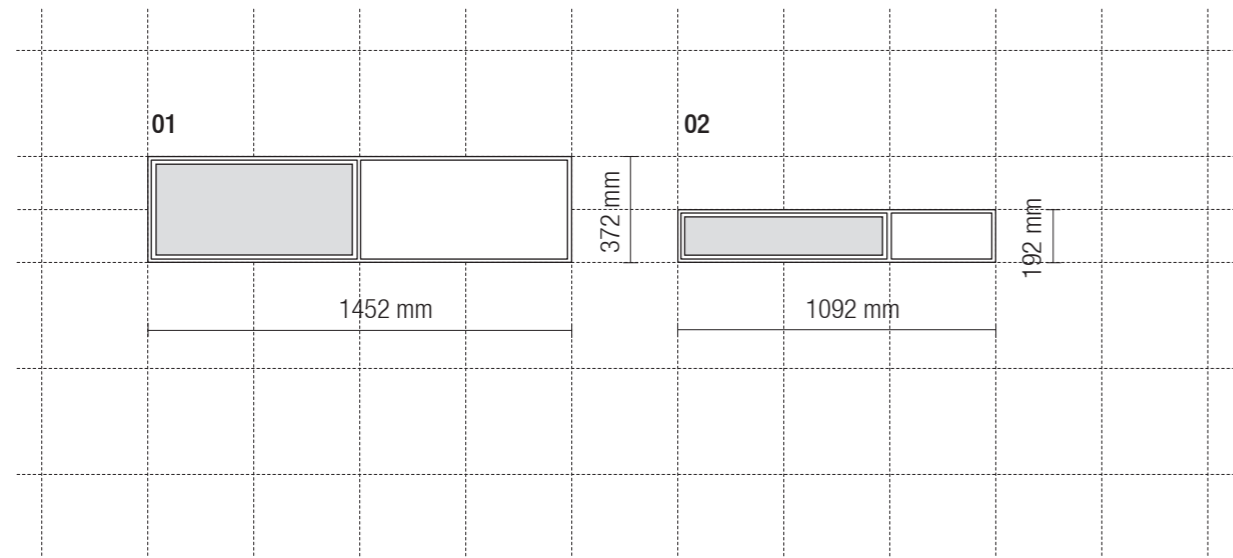

TV-Board tv board

Tiefe depth 372 mm

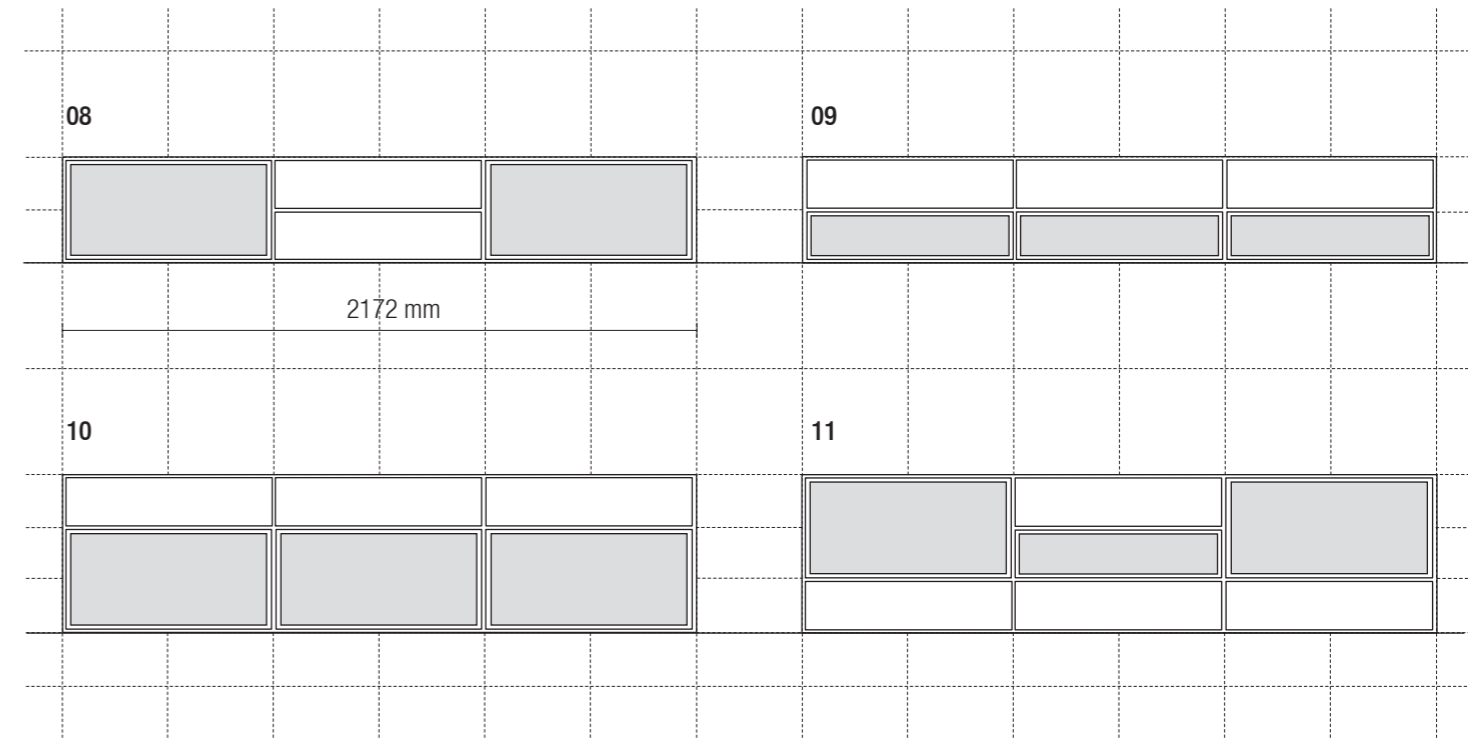

Sonstiges miscellaneous

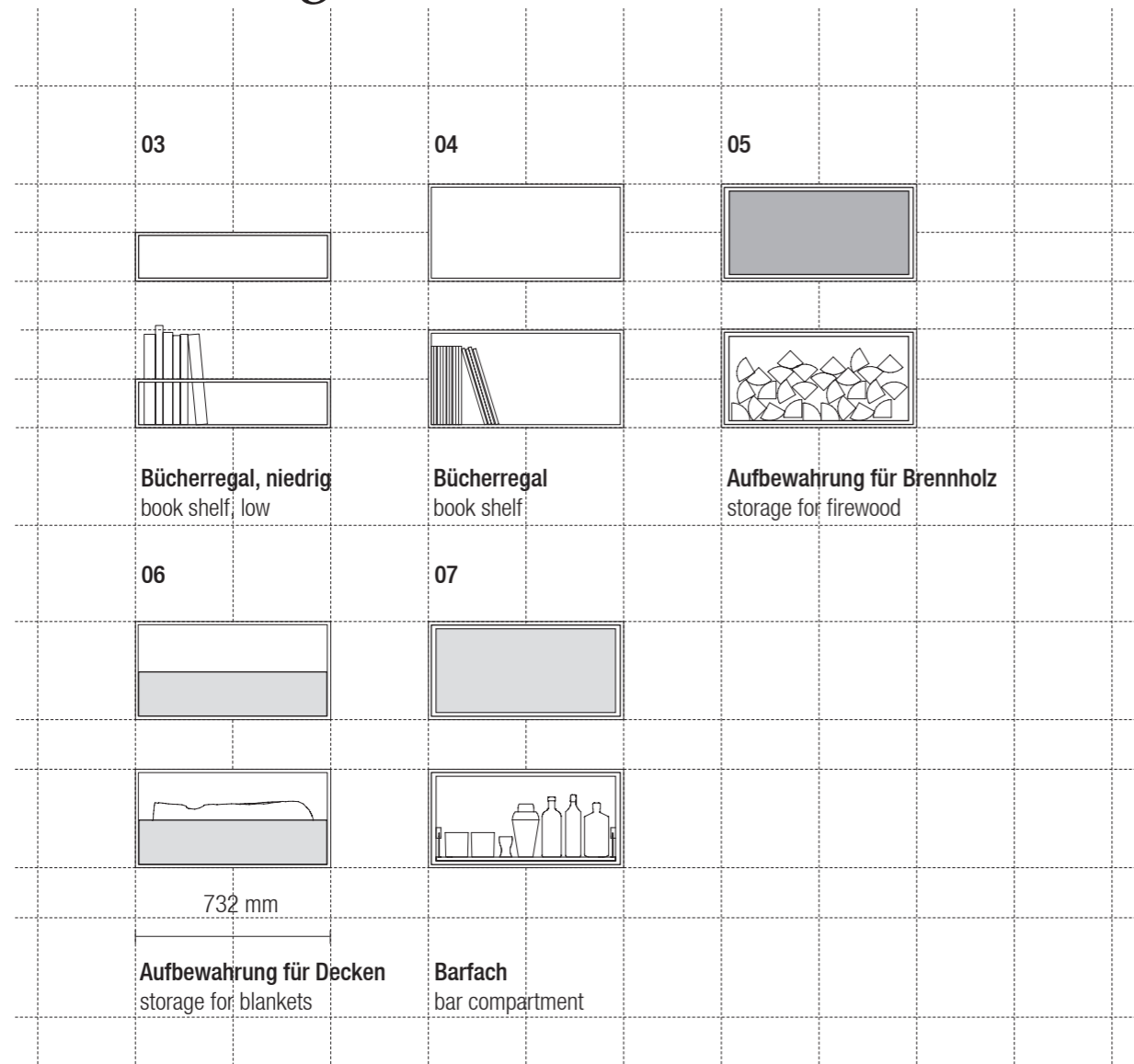

Stauraum storage space

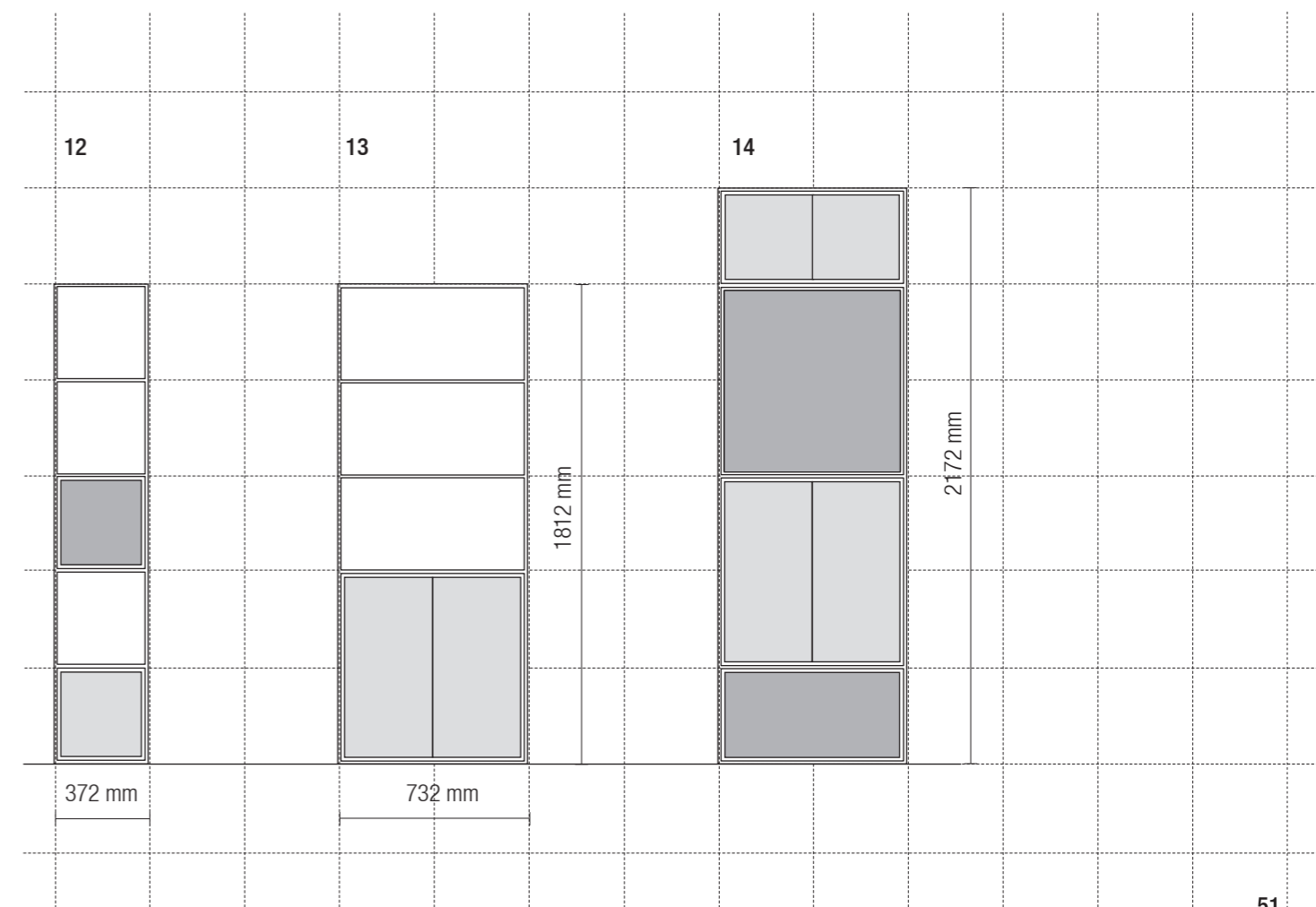

Module modules

Wohnwand

wall unit

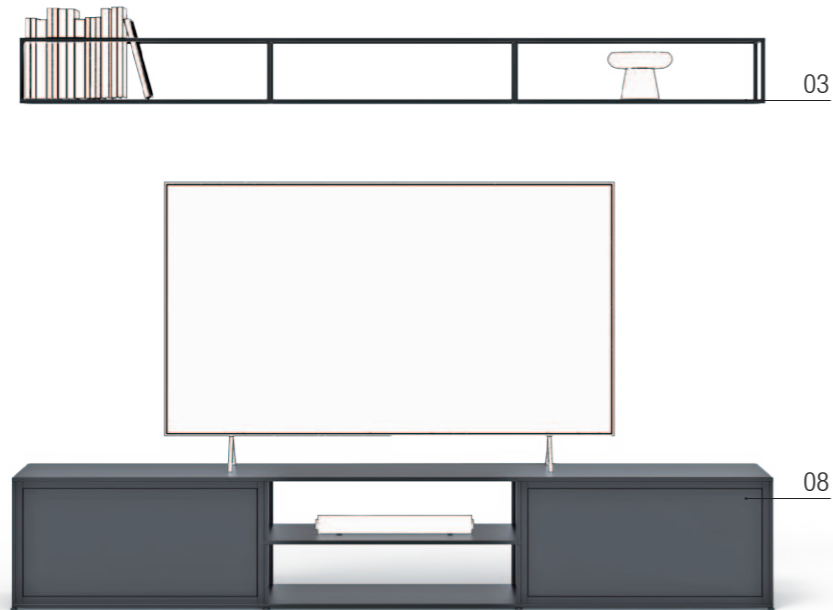

1a

Wohnwand wall unit 1a bb · 6 x 4.5
2172 x 1642 x 372 / 192 mm

Metallablagen halbe Tiefe · Top-Platten · Korpus mit Schublade · Metallablagen
metal shelves half depth · top plates · corpus with drawer · metal shelves

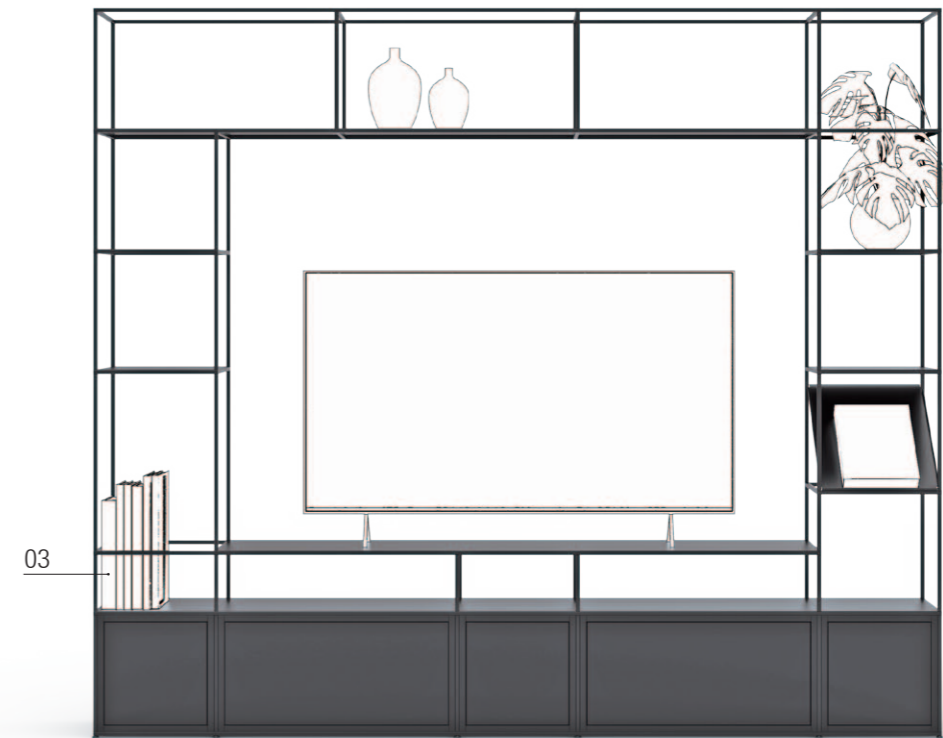

2a

Wohnwand wall unit 2a bb · 7 x 6
2532 x 2182 x 372 mm

Metallablagen · Korpus mit Schublade · Schrägablage
metal shelves · corpus with drawer · inclined shelf

Varianten variants

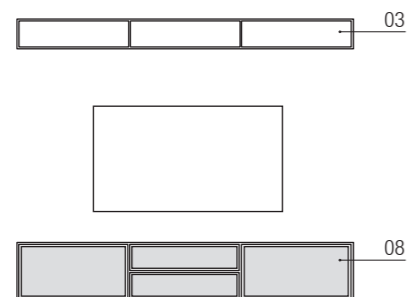

1b
2172 x 1642 x 372 / 192 mm

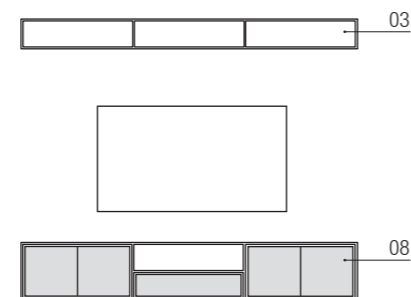

1c
2172 x 1642 x 372 / 192 mm

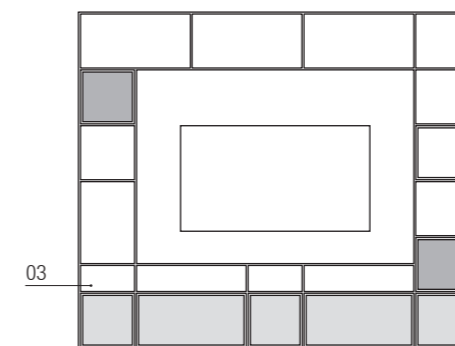

2b
2532 x 2182 x 372 mm

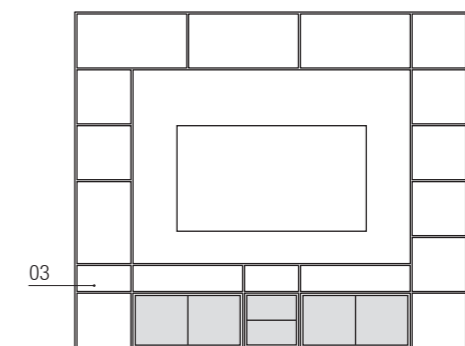

2c
2532 x 2182 x 372 mm



3a

Wohnwand wall unit 3a bb · 8 x 6
2892 x 2182 x 372 mm

Metallablagen · Korpus mit Rückwand · Korpus mit Schublade
metal shelves · corpus with back panel · corpus with drawer



4a

Wohnwand wall unit 4a bb · 10 x 5
3612 x 1822 x 372 mm

Metallablagen · Top-Platten · Korpus mit Rückwand · Korpus mit Schublade · Korpus mit Klappe
metal shelves · top-plates · corpus with back panel · corpus with drawer · corpus with drop front

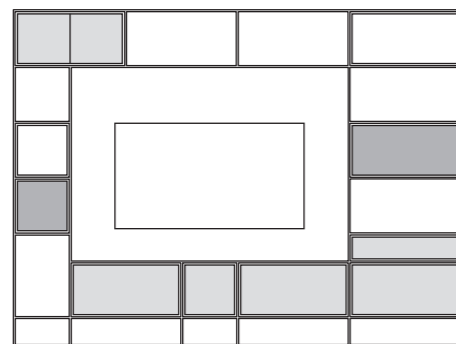

3b

2892 x 2182 x 372 mm

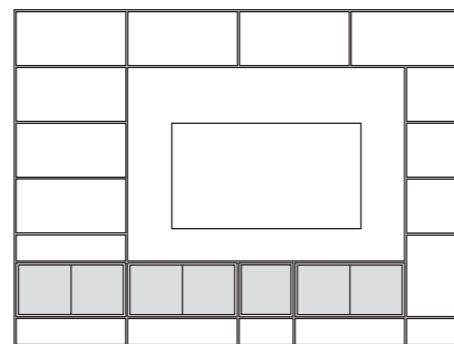

3c

2892 x 2182 x 372 mm

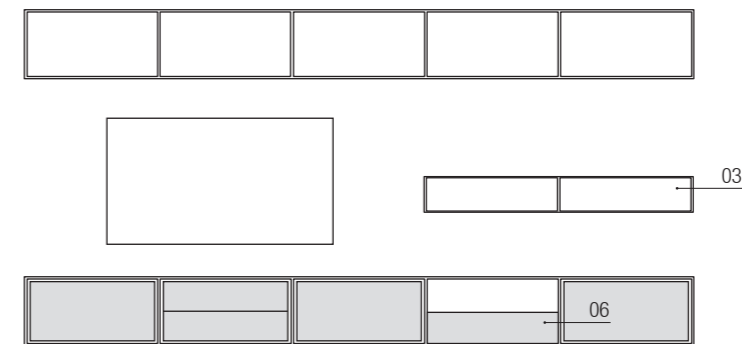

4b

3612 x 1822 x 372 mm

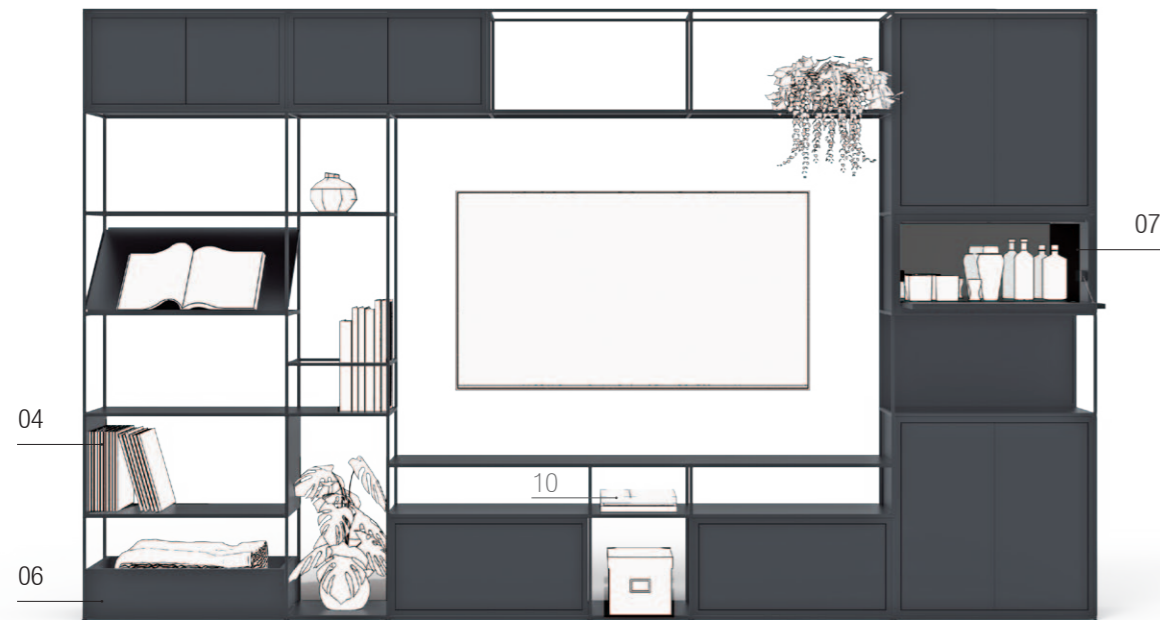

5a

Wohnwand wall unit 5a bb · 10 x 6
3612 x 2182 x 372 mm

Metallablagen · Schrägablage · Seitenwand · Korpus mit Türen ·
Korpus mit Schublade · Korpus mit Klappe · Rückwand
metal shelves · inclined shelf · lateral panel · corpus with doors ·
corpus with drawer · corpus with drop front · back panel

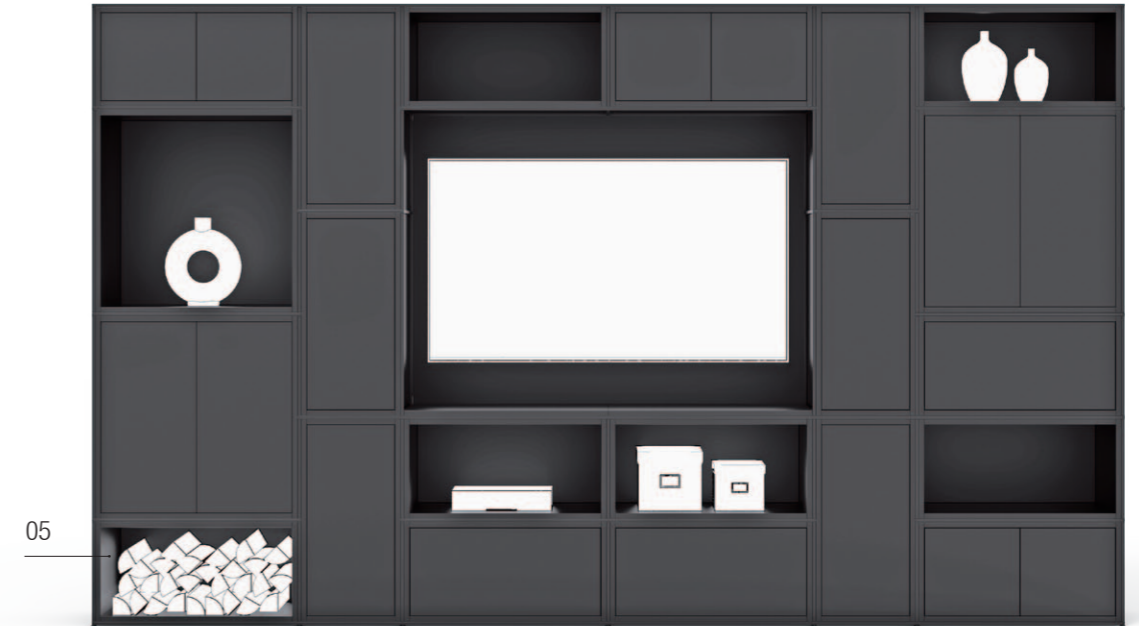

6a

Wohnwand wall unit 6a bb · 10 x 6
3612 x 2182 x 372 mm

Metallablagen · Korpus mit Türen · Korpus mit Schublade ·
Korpus mit Rückwand
metal shelves · corpus with doors · corpus with drawer ·
corpus with back panel

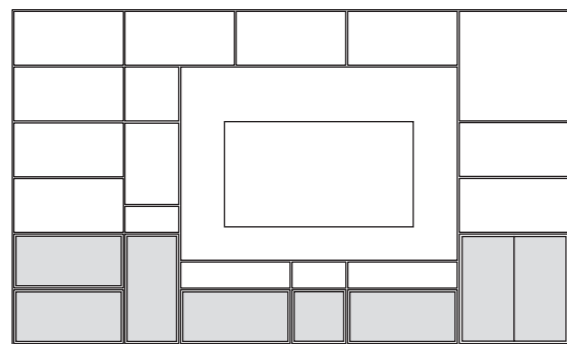

5b

3612 x 2182 x 372 mm

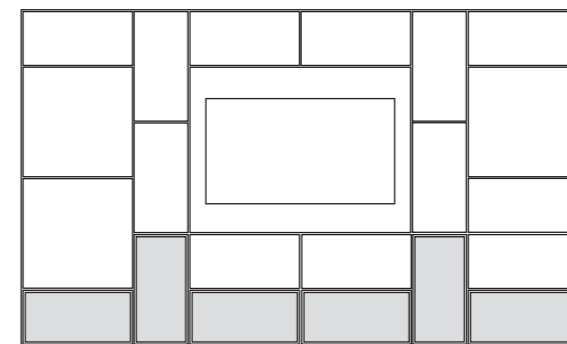

6b

3612 x 2182 x 372 mm



Schlafen

bedroom

Photo by Katie Luka on Unsplash

Nachttisch
bedside table

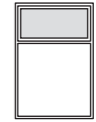

Schminktisch
vanity table

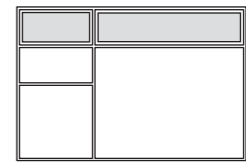

Stauraummöbel
storage furniture

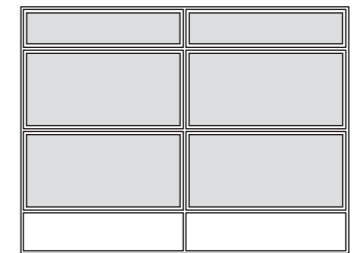

Ankleide
wardrobe

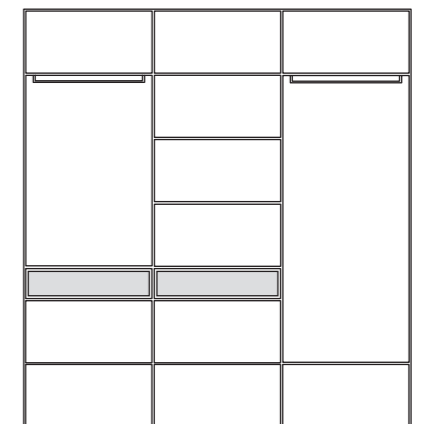

Nachttisch

bedside table

Schminktisch

vanity table

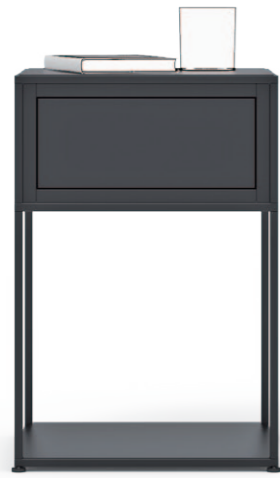

1a

Nachttisch bedside table **1a bb** · 1 x 1.5
372 x 562 x 372 mm

Top-Platte · Korpus mit Schublade · Metallablage
top plate · corpus with drawer · metal shelf



1b

Nachttisch bedside table **1b bw** · 1 x 1.5
372 x 562 x 372 mm

Top-Platte · Metallablage ·
Korpus mit Tür
top plate · metal shelf ·
corpus with door



1a

Schminktisch vanity table **1a bb** · 3 x 2
1092 x 742 x 372 mm

Top-Platte aus Glas · Metallablage ·
Korpus mit Schublade
top plate made of glass · metal shelf ·
corpus with drawer



Variante
variant

1b
1092 x 742 x 372 mm

Konfigurationen configurations



2
372 x 192 x 372 mm

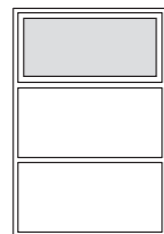

3
372 x 562 x 372 mm

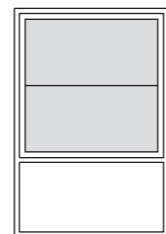

4
372 x 562 x 372 mm

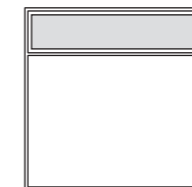

2
732 x 742 x 372 mm

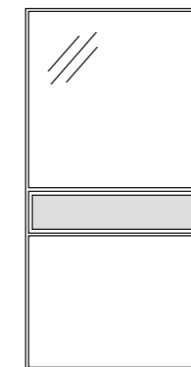

3
732 x 1462 x 372 mm

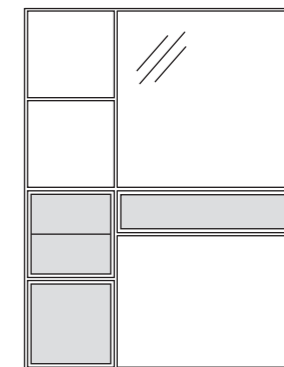

4
1092 x 1462 x 372 mm

Stauraummöbel

storage furniture

Die Stauraummöbel für das Schlafzimmer sind angepasst auf die Ankleiden ebenfalls in der **Sondertiefe 492 mm erhältlich.**
The storage units for the bedroom are also available in the special depth of 492 mm to match the closets.

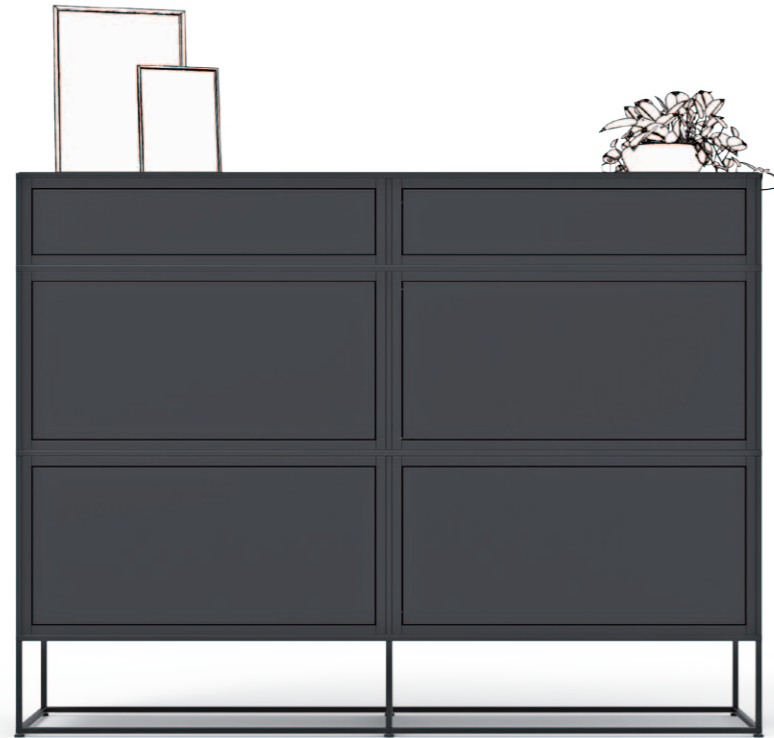

1a

Kommode dresser 1a bb · 4 x 3
1452 x 1102 x 492 mm

Top-Platten · Korpus mit Schublade
top plates · corpus with drawer



2
732 x 1102 x 492 mm



3
1092 x 742 x 492 mm

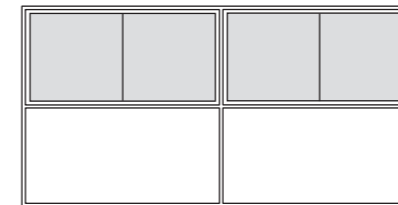

4
1452 x 742 x 492 mm

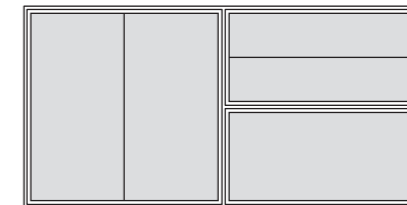

5
1452 x 742 x 492 mm

Varianten variants



1b
1452 x 1102 x 492 mm

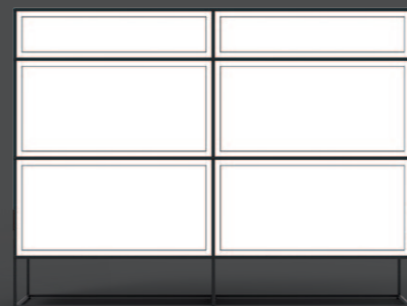

1c
1452 x 1102 x 492 mm

Im CAROLINE HOME & LIVING Konfigurator finden Sie alle hier abgebildeten Konfigurationen und können diese auch individuell anpassen und ausstatten. Einige Module sollten aufgrund ihrer Form und Größe an der Wand befestigt werden, um ein Kippen zu vermeiden. Bitte kontaktieren Sie uns für weitere Informationen!

In the CAROLINE HOME & LIVING configurator you can find all the configurations shown here and can also customise and equip them individually. Due to their shape and size, some modules should be fixed to the wall to prevent them from tipping over. Please contact us for further information!

Alle Maßangaben in mm, Reihenfolge: Breite x Höhe x Tiefe
All dimensions in mm, order: width x height x depth

Ankleide

wardrobe

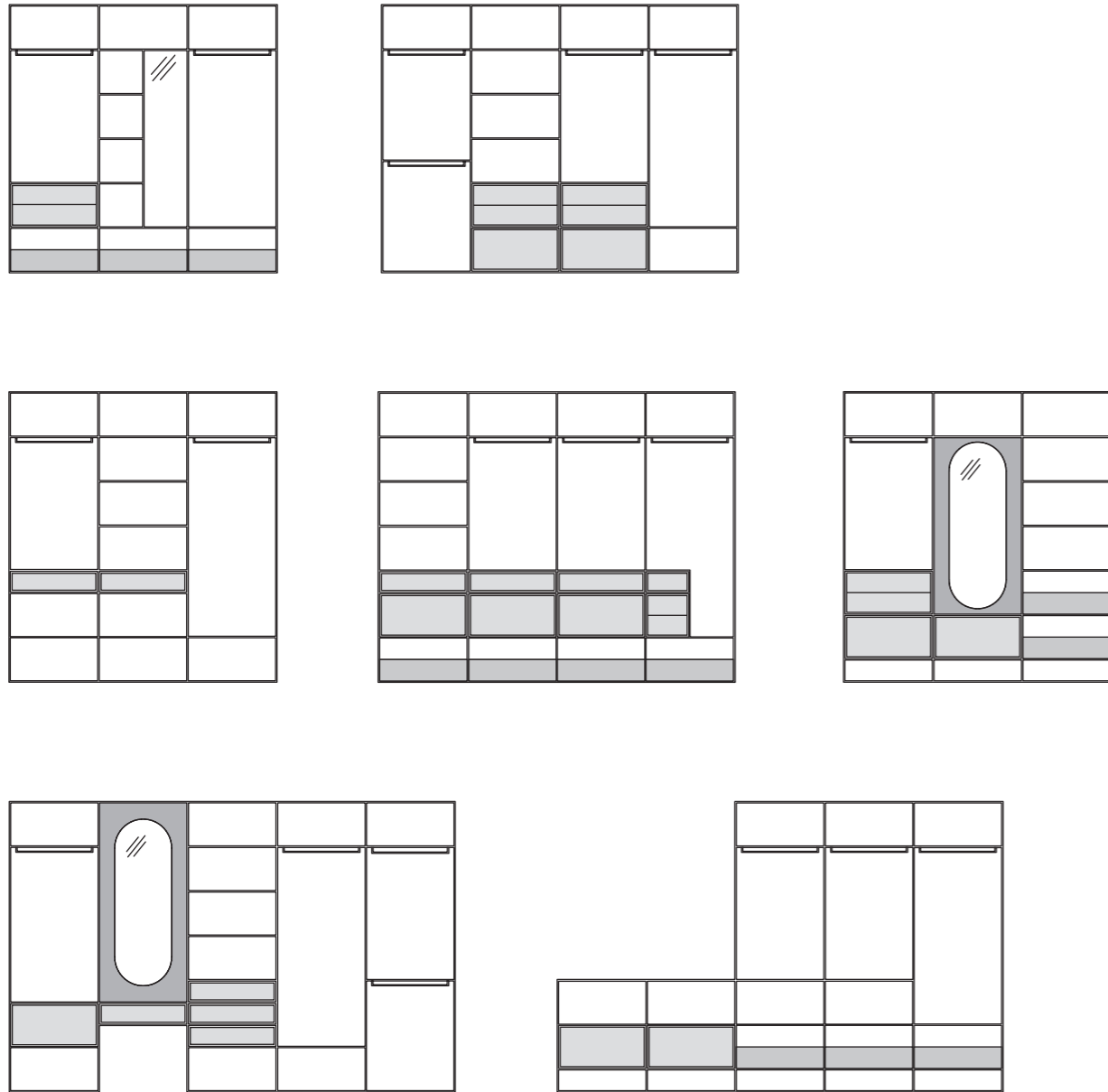

Im CAROLINE HOME & LIVING Konfigurator finden Sie alle hier abgebildeten Konfigurationen und können diese auch individuell anpassen und ausstatten. Einige Module sollten aufgrund ihrer Form und Größe an der Wand befestigt werden, um ein Kippen zu vermeiden. Bitte kontaktieren Sie uns für weitere Informationen!

In the CAROLINE HOME & LIVING configurator you can find all the configurations shown here and can also customise and equip them individually. Due to their shape and size, some modules should be fixed to the wall to prevent them from tipping over. Please contact us for further information!



Photo by Skylar Kang on Pexels



Photo by Katie Luka on Unsplash



Photo by Jason Hafso on Unsplash

Stauraum & Spiegel

storage space & mirror

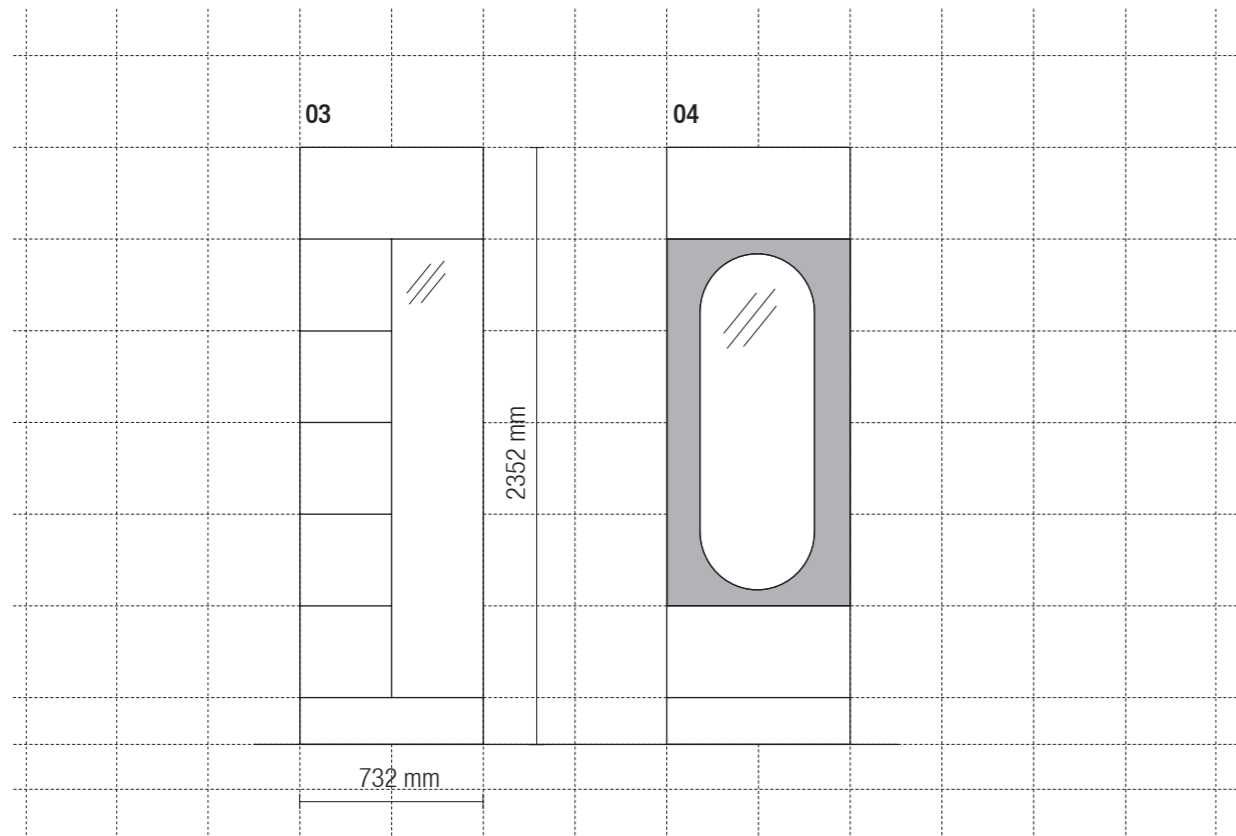

Kleiderstange & Stauraum

clothes rail & storage space

Tiefe depth 492 mm

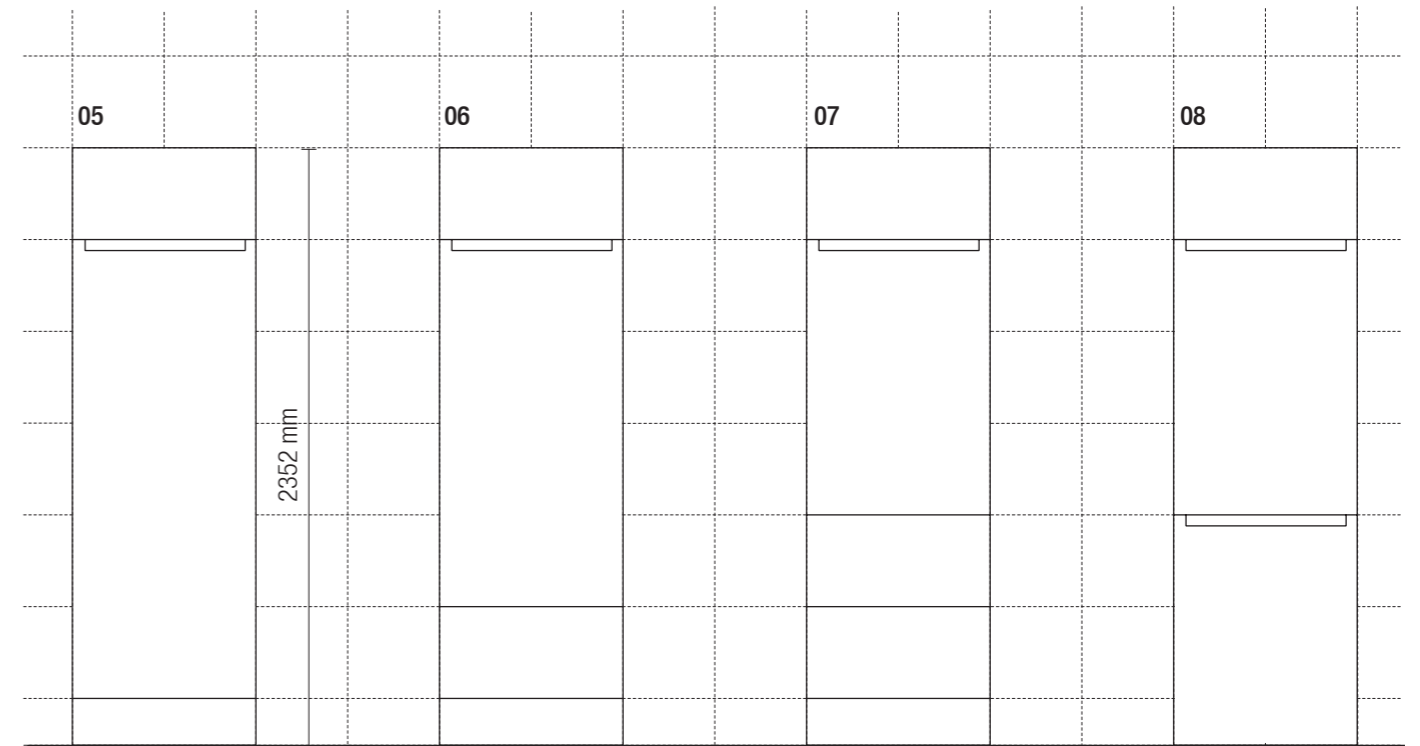

Stauraum

storage space

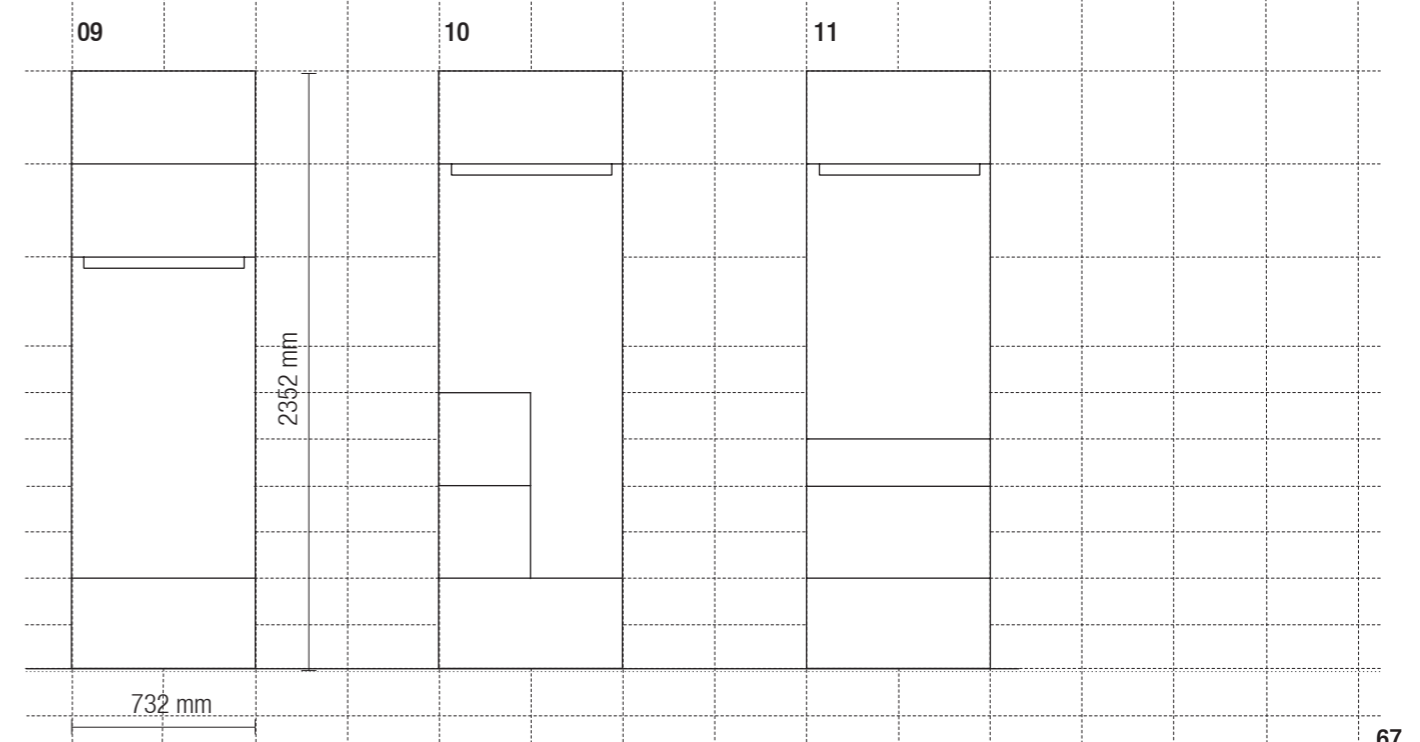
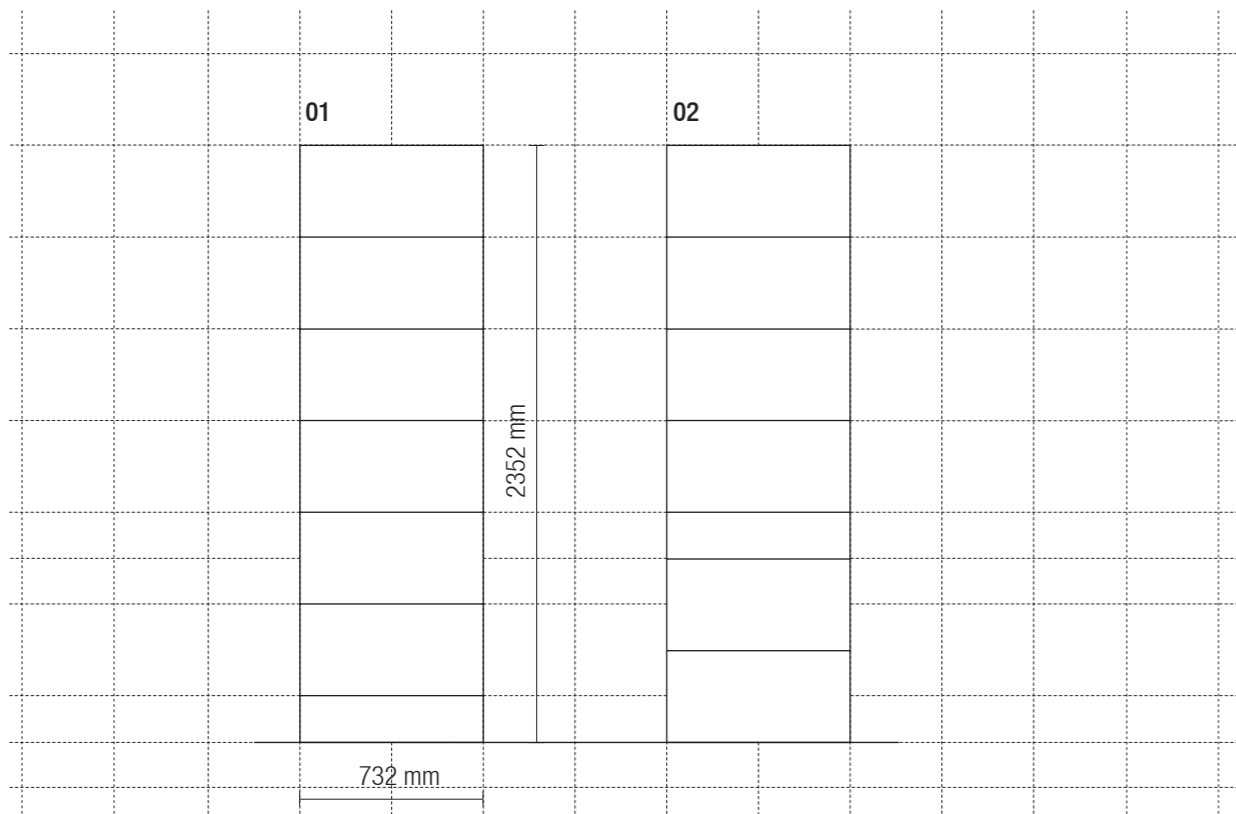

Module modules

Ankleide wardrobe



1a

Ankleide wardrobe 1a bb · 6 x 6
2172 x 2182 x 492 mm

Kleiderstangen · Metallablagen · Korpus mit Schubladen ·
Spiegel · Schuhablagen
clothes rails · metal shelves · corpus with drawers · mirror ·
shelves for shoes

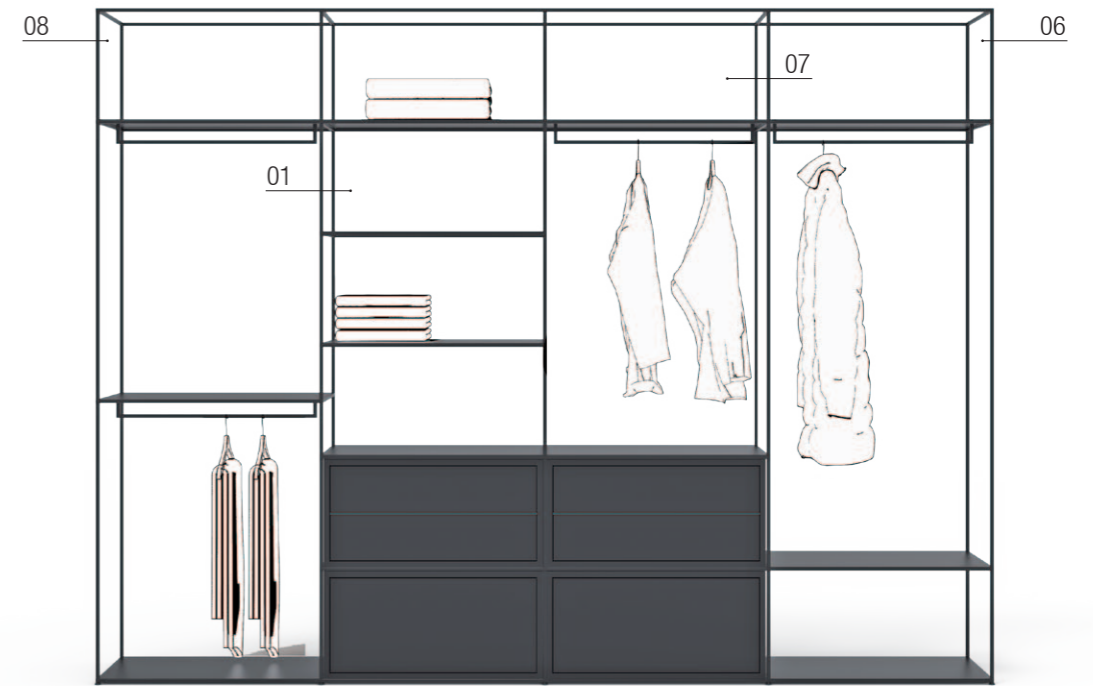

2a

Ankleide wardrobe 2a bb · 8 x 6
2892 x 2182 x 492 mm

Kleiderstangen · Metallablagen · Korpus mit Schubladen
clothes rails · metal shelves · corpus with drawers

Varianten variants

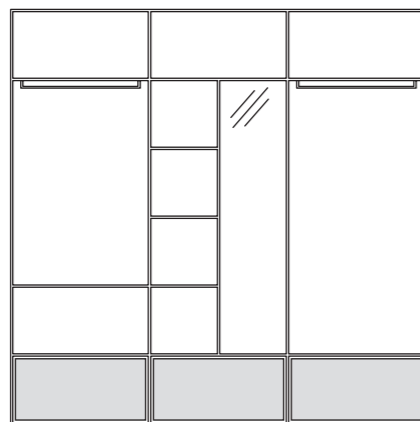

1b

2172 x 2182 x 492 mm

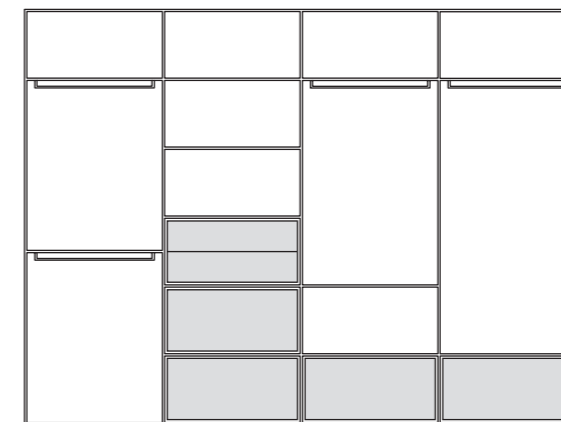

2b

2892 x 2182 x 492 mm

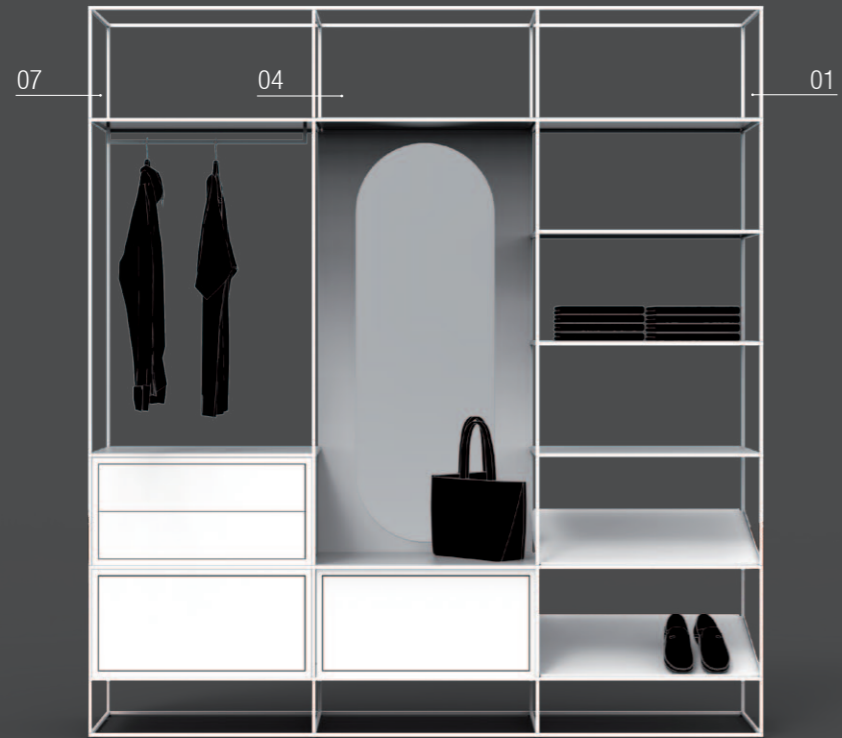

3a

Ankleide wardrobe 3a ww · 6 x 6.5
2172 x 2362 x 492 mm

Kleiderstange · Metallablagen · Korpus mit Schubladen ·
Rückwand mit Spiegel · Schuhablagen
clothes rail · metal shelves · corpus with drawers · back panel with mirror ·
shelves for shoes

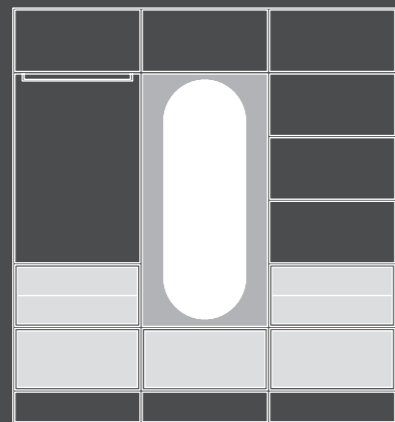

3b

2172 x 2362 x 492 mm



4a

Ankleide wardrobe 4a ww · 6 x 6.5
2172 x 2362 x 492 mm

Kleiderstangen · Metallablagen · Korpus mit Schublade
clothes rails · metal shelves · corpus with drawer

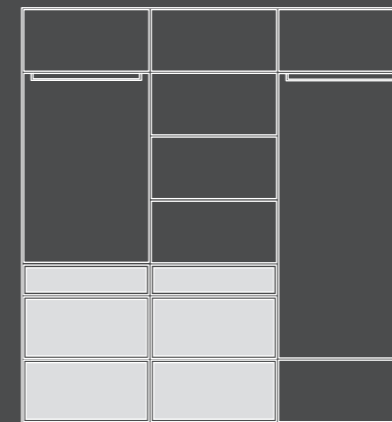

4b

2172 x 2362 x 492 mm

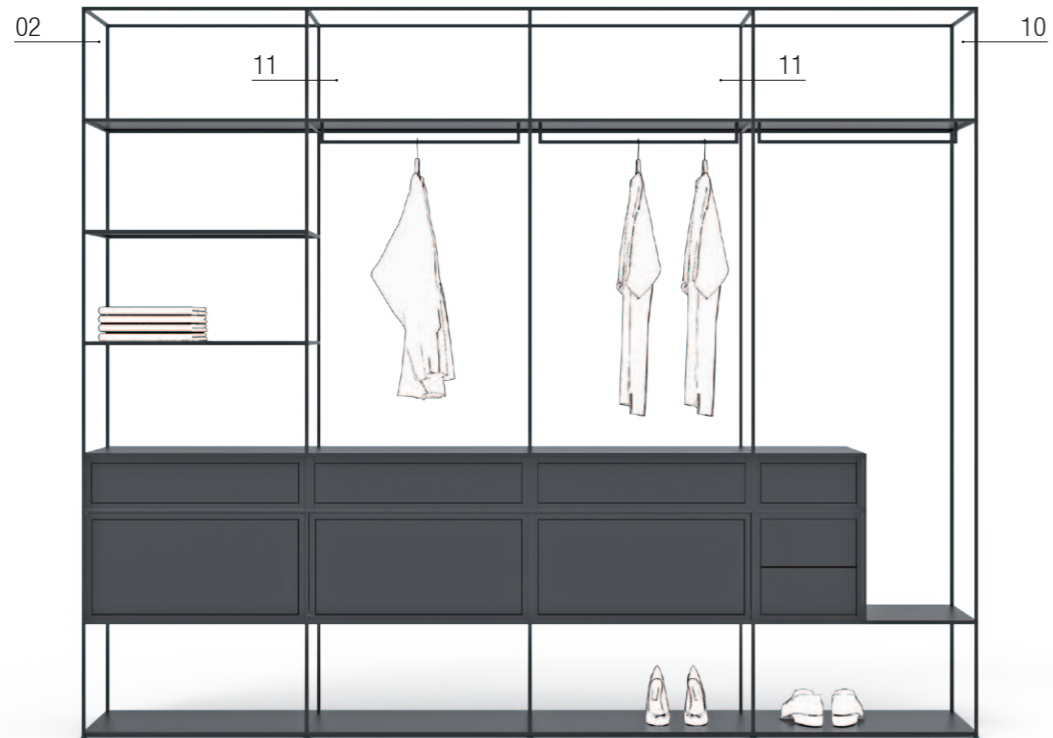

5a

Ankleide wardrobe 5a bb · 8 x 6.5
2892 x 2362 x 492 mm

Kleiderstangen · Metallablagen · Korpus mit Schubladen
clothes rails · metal shelves · corpus with drawers

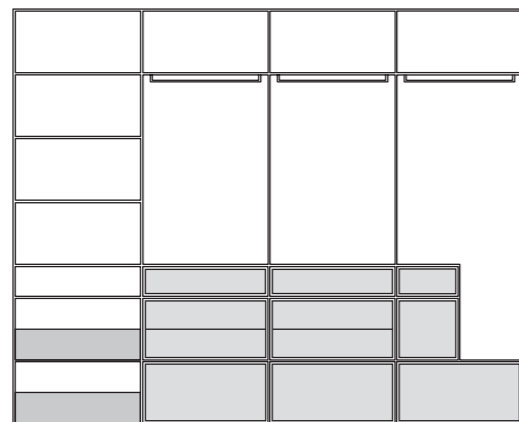

5b

2892 x 2362 x 492 mm

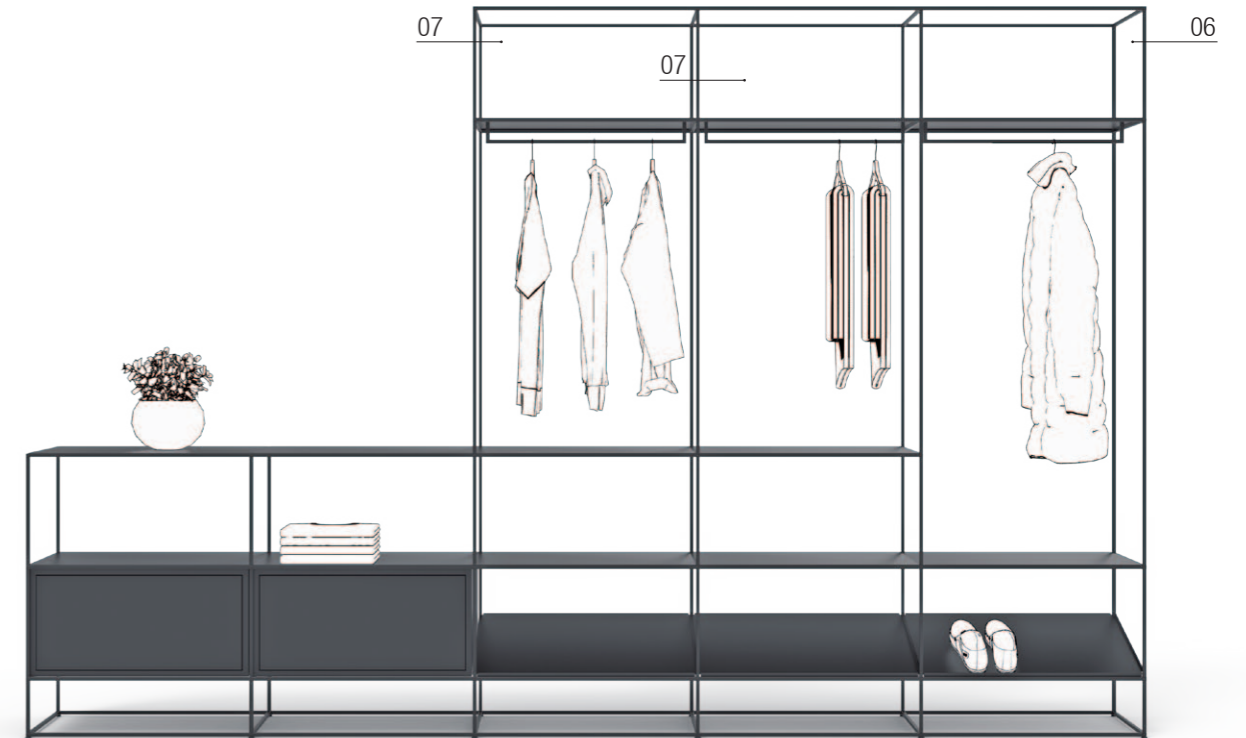

6a

Ankleide wardrobe 6a bb · 10 x 6.5
3612 x 922 / 2362 x 492 mm

Top-Platte · Kleiderstangen · Metallablagen ·
Korpus mit Schublade · Schuhablagen
top-plate · clothes rails · metal shelves ·
corpus with drawer · shelves for shoes

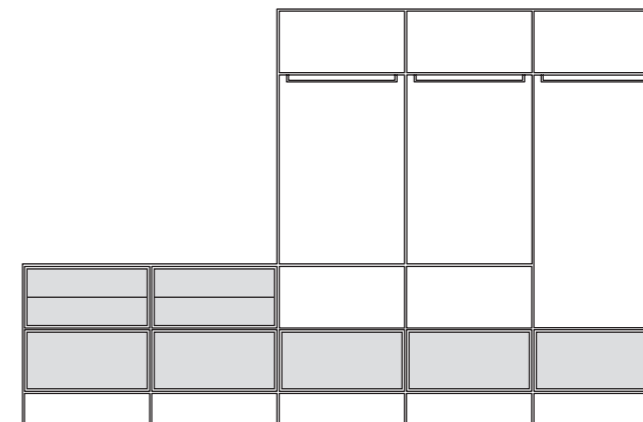

6b

3612 x 922 / 2362 x 492 mm

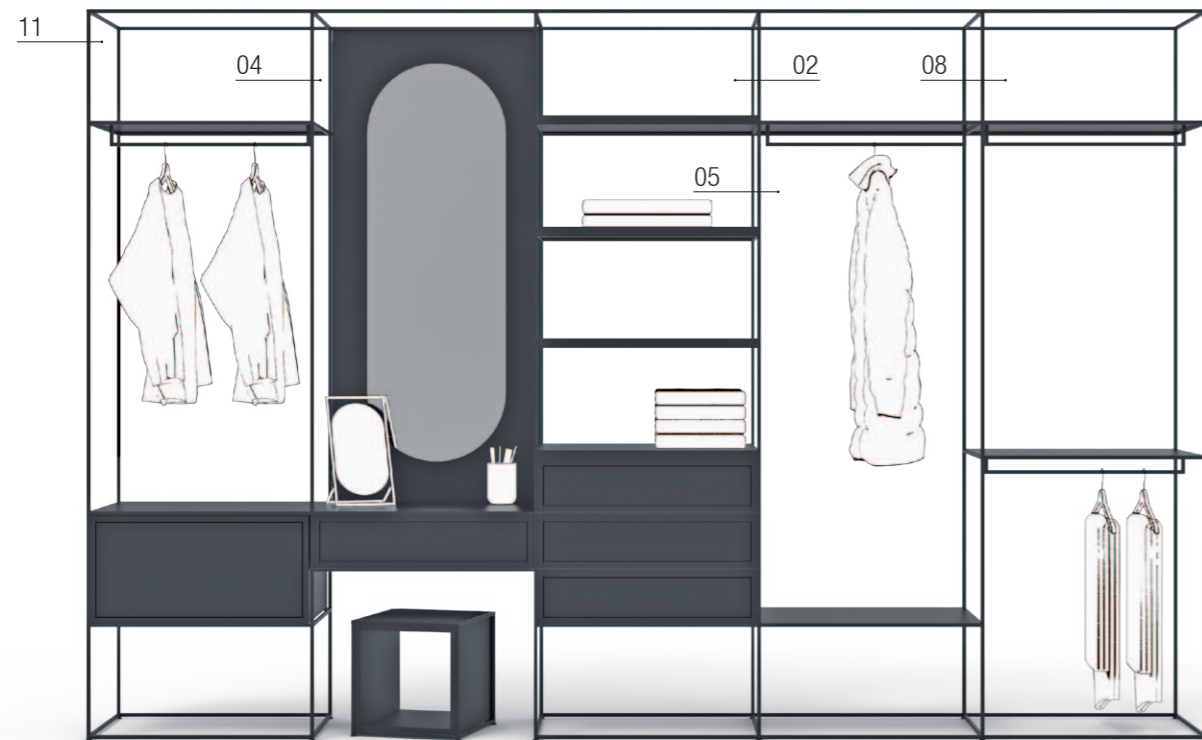

7a

Ankleide wardrobe 7a bb · 10 x 6.5
3612 x 2362 x 492 mm

Kleiderstangen · Metallablagen · Dekorablagen · Korpus mit Schublade ·
Rückwand mit Spiegel · Sitzhocker
clothes rails · metal shelves · wooden decor shelves · corpus with drawer ·
back panel with mirror · seat

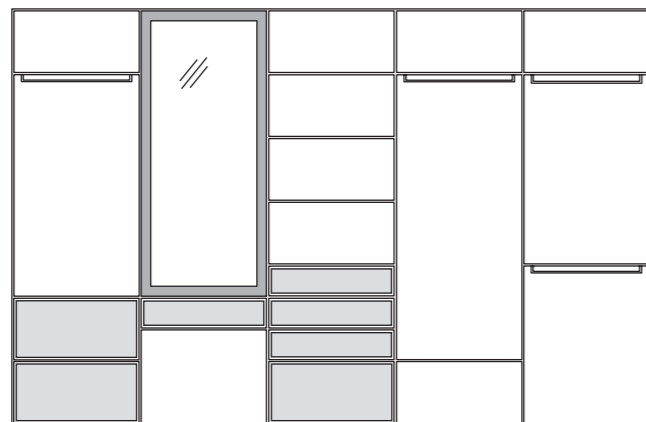

7b

3612 x 2362 x 492 mm



Nachttisch bedside table
1a bb · 1 x 1.5

Photo by Krystal Black on Unsplash

Bad

bathroom



Spiegelschrank
mirror cabinet

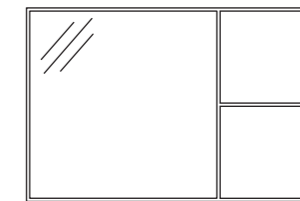

Wandregal
wall rack

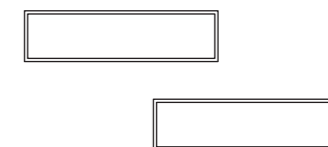

Stauraummöbel
storage furniture



Wäschesammler
laundry bin

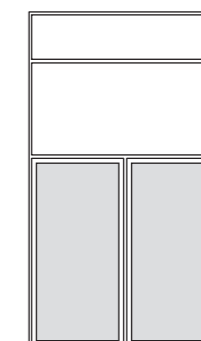

Spiegelschrank

mirror cabinet



1

Spiegelschrank mirror cabinet 1 bb · 3 x 2
1092 x 732 x 192 mm

Metallablagen halbe Tiefe · Spiegel
metal shelves half depth · mirror

Wandregal

wall rack



1

Wandregal wall rack 1 bb · 2 x 0.5
732 x 192 x 192 mm

Metallablagen halbe Tiefe
metal shelves half depth

Konfigurationen configurations

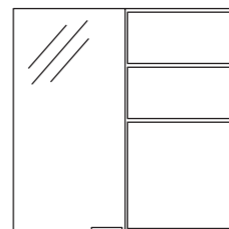
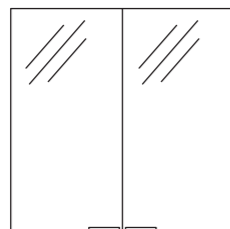

2

732 x 732 x 192 mm

3

732 x 732 x 192 mm

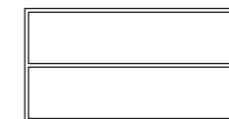

2

372 x 732 x 192 mm

3

732 x 372 x 192 mm

Regal

shelving unit

Trolley

trolley



1

Regal shelving unit 1 ww · 1 x 5
372 x 1822 x 372 mm

Metallablagen · Korpus mit Tür
metal shelves · corpus with door



1a

Trolley trolley 1a ww · 1 x 2.5
384 x 978 x 372 mm

Boxen · Metallablage
boxes · metal shelf



1b

Trolley trolley 1b wb · 1 x 2.5
384 x 978 x 372 mm

Metallablage · Korpus mit Schublade · Box
metal shelf · corpus with drawer · box

Konfigurationen configurations



2

372 x 1452 x 372 mm



3

732 x 922 x 372 mm



2

372 x 798 x 372 mm



3

732 x 978 x 372 mm

Wäschesammler

laundry bin



1a

Wäschesammler laundry bin 1a bb · 2 x 3.5
732 x 1282 x 372 mm

Metallablagen · Korpus mit Wäschekorb
metal shelves · corpus with laundry basket



Variante
variant

1b
732 x 1282 x 372 mm

Konfigurationen configurations

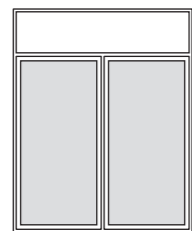

2
732 x 922 x 372 mm



3
372 x 1462 x 372 mm



Regal shelving unit 2 bb · 1 x 4



Küche

kitchen

Photo by Jean-Philippe Delberghe on Unsplash

Trolley
trolley



Wandregal
wall rack



Stauraummöbel
storage furniture

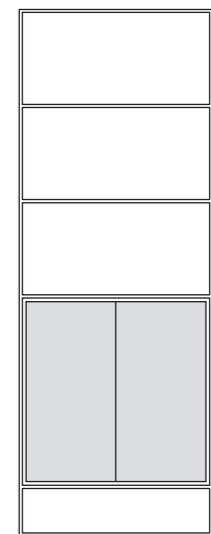

Ablagen shelves

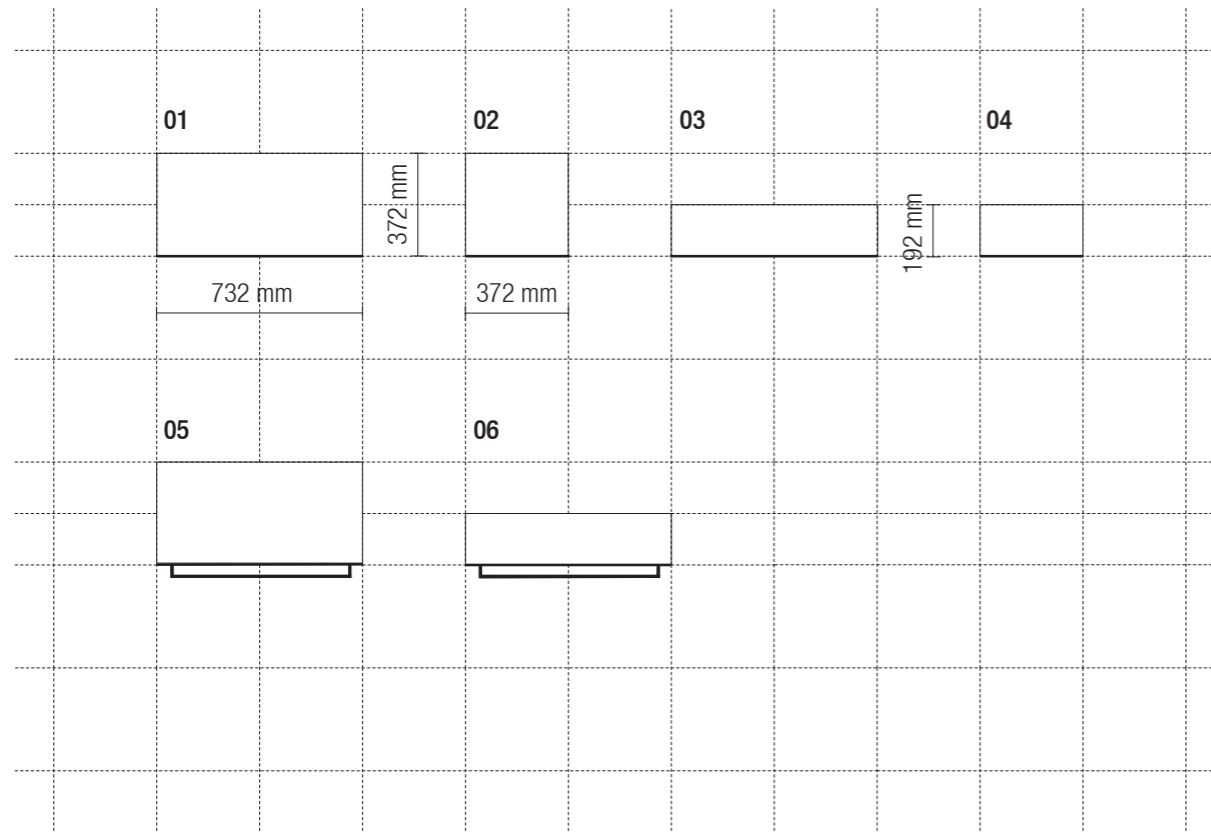

Sonstiges miscellaneous

Tiefe depth 372 mm

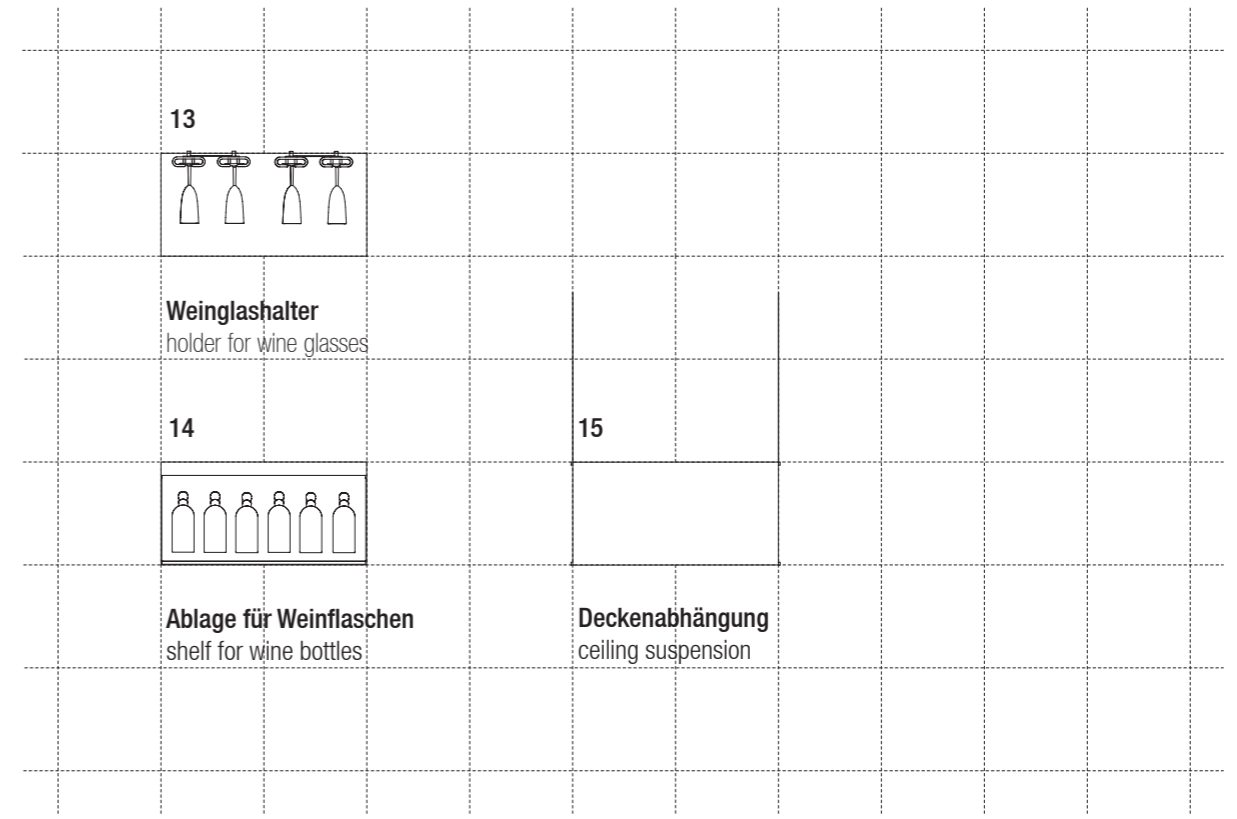

Stauraum storage space

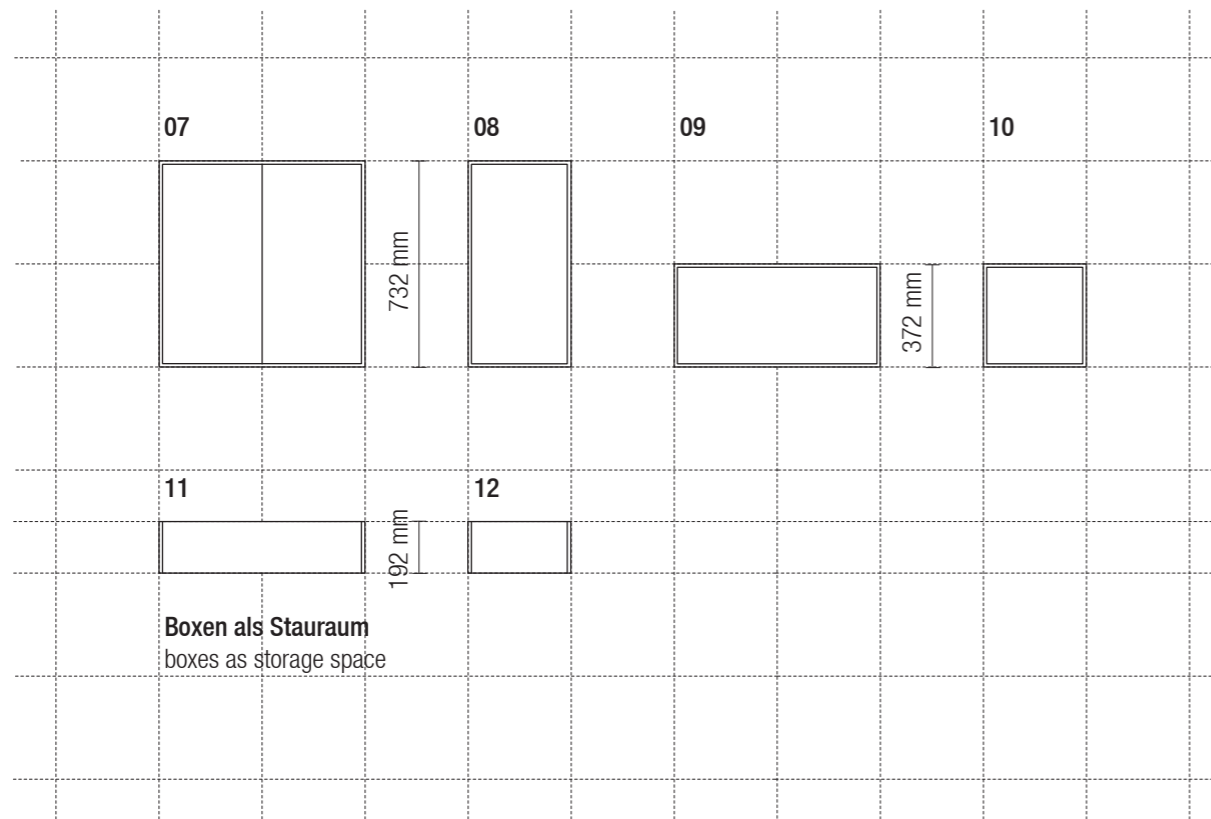

1

Staurummöbel storage furniture 5 bb · 4 x 2.5
1452 x 922 x 372 mm

Metallablagen · metal shelves

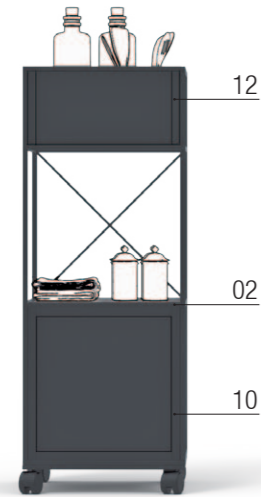

1a

Trolley trolley 1a bb · 1 x 2.5
372 x 978 x 378 mm

Box · Metallablage · Korpus mit Tür · Rollen
box · metal shelf · corpus with door · castors

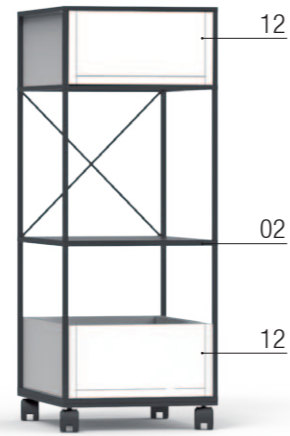

1b

Trolley trolley 1b bw · 1 x 2.5
372 x 978 x 378 mm

Boxen · Metallablage · Rollen
boxes · metal shelf · castors

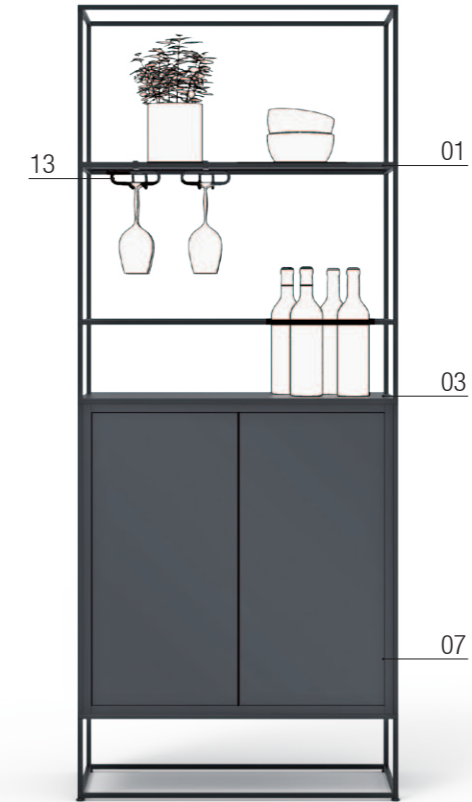

1

Stauraummöbel storage furniture 1 bb · 2 x 5
372 x 1822 x 372 mm

Metallablage · Korpus mit Türen · Weinglashalter
metal shelf · corpus with doors · holder for wine glasses

Konfigurationen configurations

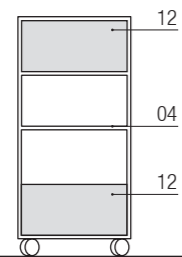

2
372 x 798 x 372 mm

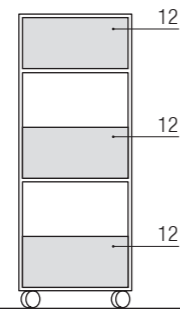

3
372 x 978 x 372 mm

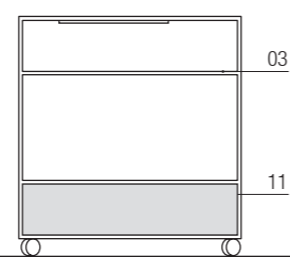

4
732 x 798 x 372 mm

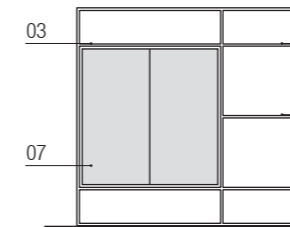

2
1092 x 1102 x 372 mm

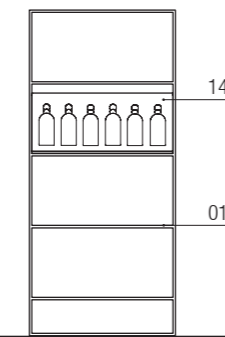

3
732 x 1462 x 372 mm

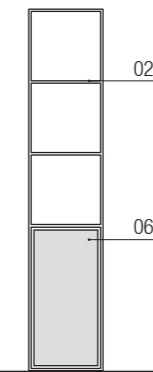

4
372 x 1822 x 372 mm

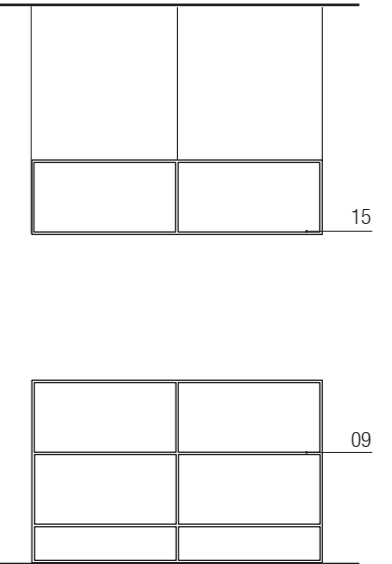

5
1452 x 922 / 372 x 372 mm

Wandregal

wall rack

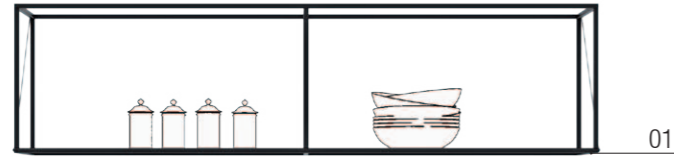

1

Wandregal wall rack 1 bb · 4 x 1
1452 x 372 x 372 mm

Metallablagen · metal shelves

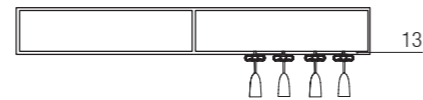
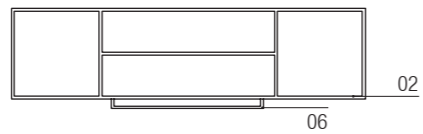
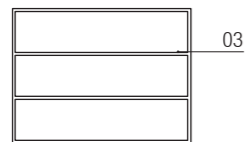

2

732 x 562 x 192 mm

3

1452 x 372 x 372 mm

4

1452 x 192 x 372 mm

Konfigurationen configurations



Wandregal wall rack 2 bb · 2 x 1.5



Arbeiten

work space

Photo by Phil on Unsplash

Trolley
trolley

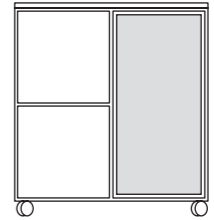

Regal
shelving unit

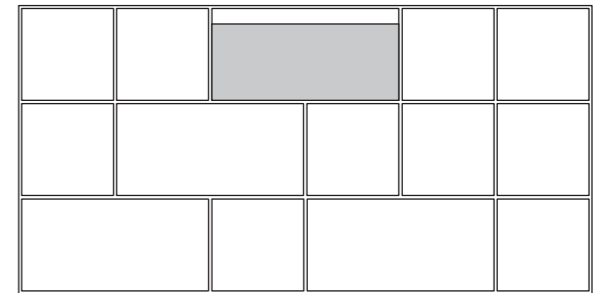

Arbeitsplatz
workplace

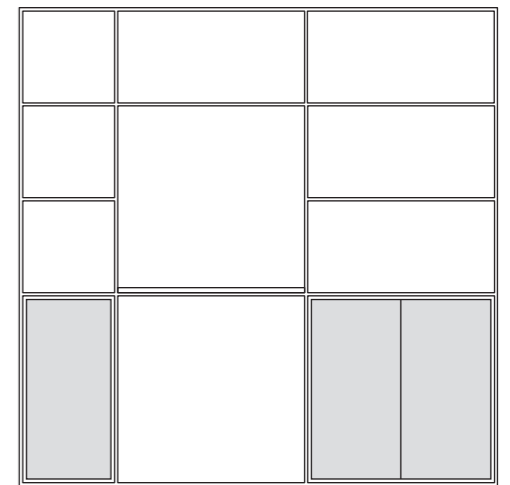

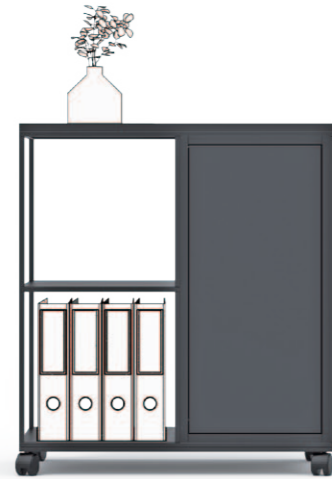

1

Trolley trolley 1 bb · 2 x 2
732 x 798 x 372 mm

Topplatte · Metallablagen · Korpus mit Tür · Rollen
top-plate · metal shelves · corpus with door · castors



1

Regal shelving unit 1 bb · 6 x 3
2172 x 1102 x 372 mm

Topplatten · Metallablagen · Rückwände · Seitenwände
top-plates · metal shelves · back panels · lateral panel

Konfigurationen configurations

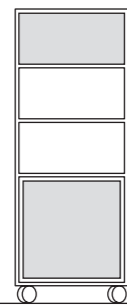

2
372 x 978 x 372 mm

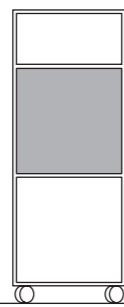

3
372 x 978 x 372 mm

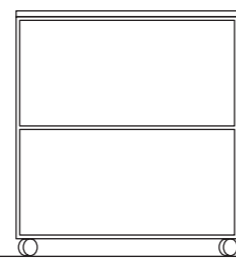

4
732 x 798 x 372 mm

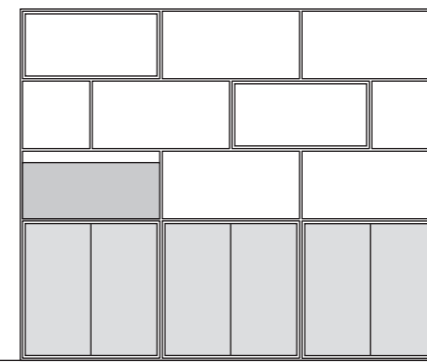

2
2172 x 1822 x 372 mm

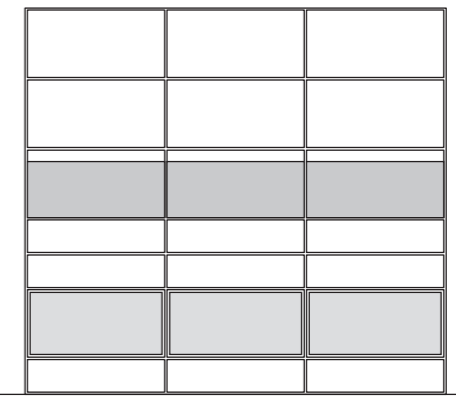

3
2172 x 2002 x 372 mm

Arbeitsplatz

workplace



1a

Arbeitsplatz workplace 1a bb · 5 x 5
1812 x 1822 x 372 + **Tischplatte** table top

Metallablagen · Dekorablagen · Korpus mit Türen ·
Seitenwände · Tischkonsole
metal shelf · wooden decor shelves · corpus with doors ·
lateral panel · desk console

Varianten variants



1a
Seitenansicht side view

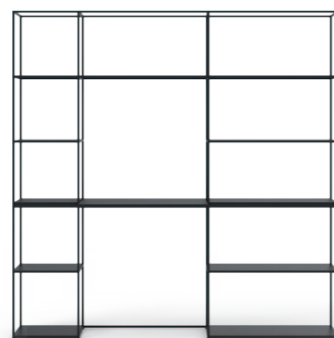

1b
1812 x 1822 x 372 mm



1c
1812 x 1822 x 372 mm

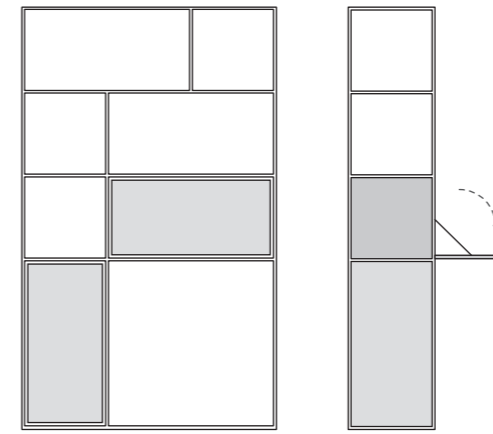

2
1102 x 1822 x 372 mm

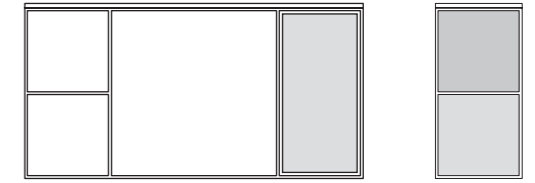

3
1452 x 742 x 372 mm

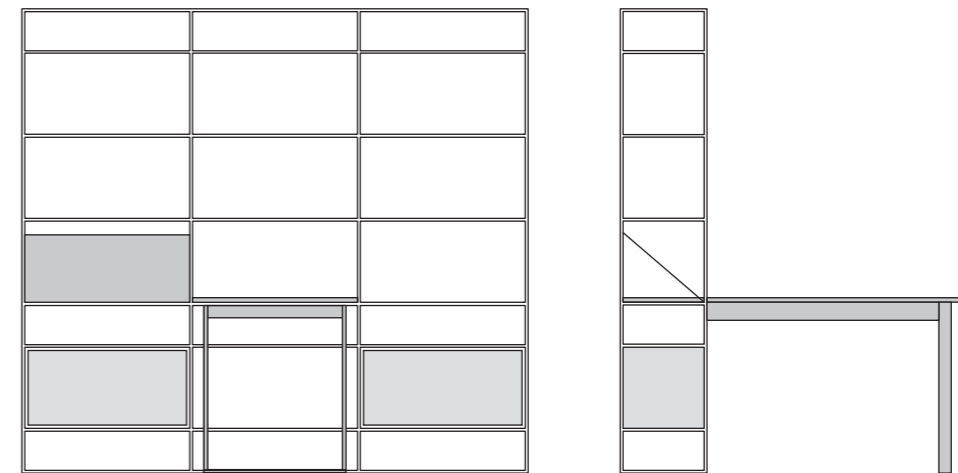

4
2172 x 2002 x 372 mm + **Tischplatte** desk top

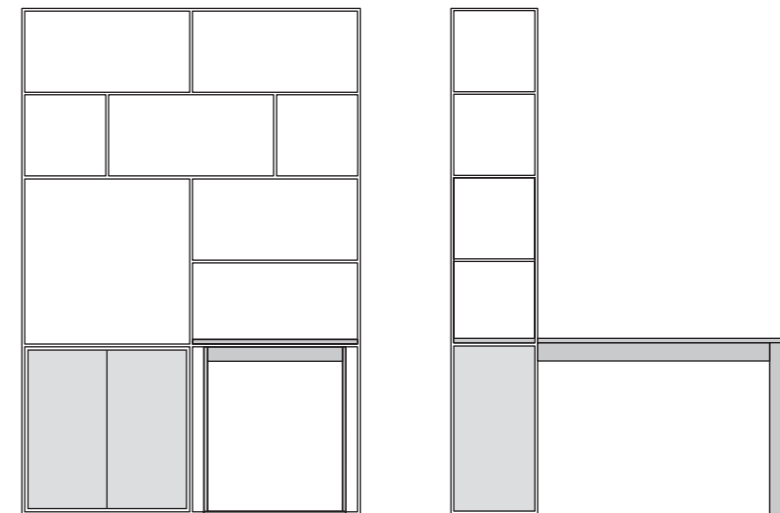

5
1452 x 2182 x 372 mm + **Tischplatte** desk top

Arbeitsplätze sollten aufgrund ihrer Form, Größe und Nutzung an der Wand befestigt werden.
Workplaces should be attached to the wall due to their shape, size and use.



Regal shelving unit 7 bb · 6 x 6

Sideboard sideboard 1a bb · 5 x 2

Showroom

show room



Entdecken Sie auf über 600 m² Top-Neuheiten, Trends und Ideen aus den Bereichen Ladenbau und Warenpräsentation! Das Team von concept-s freut sich auf Ihren Besuch!

Öffnungszeiten in der Steinbeisstraße 8, 73614 Schorndorf:
Montag – Freitag: 9 – 18 Uhr, Samstag: nach Vereinbarung

Bitte vereinbaren Sie vorher einen Termin mit uns:
Tel +49 (0) 71 81-9 93 71-0, info@concept-s-design.com

Discover innovations, trends and ideas from the shop design and furnishing sector on more than 600 m² ! The concept-s team is looking forward to your visit!

Opening hours at Steinbeisstraße 6, 73614 Schorndorf:
Monday - Friday: 9 am - 6 pm, Saturday: on request

Please make an appointment with us in advance:
Tel +49 (0) 71 81-9 93 71-0, info@concept-s-design.com

□ CAROLINE[®] by [concept·s][®]

mehr Informationen unter
more Informationen at
www.caroline-system.com

[concept·s][®]

concept-s
Ladenbau & Objekt-design GmbH
Steinbeisstraße 8, 73614 Schorndorf
Deutschland Germany

Tel +49 (0) 71 81 9 93 71 - 0
info@concept-s-design.com
www.caroline-system.com
www.concept-s-design.com

[concept·s][®]

concept-s

Ladenbau & Objektdesign GmbH
Steinbeisstraße 8, 73614 Schorndorf
Deutschland Germany

Tel +49 (0) 71 81 9 93 71 - 0

info@concept-s-design.com
www.caroline-system.com
www.concept-s-design.com

